



Industrial Router Lite Series

UR32L

User Guide



Preface

Thanks for choosing Milesight UR32L industrial cellular router. The UR32L industrial cellular router delivers tenacious connection over network with full-featured design such as automated failover/failback, extended operating temperature, dual SIM cards, hardware watchdog, VPN, Fast Ethernet and beyond.

This guide describes how to configure and operate the UR32L industrial cellular router. You can refer to it for detailed functionality and router configuration.

Readers

This guide is mainly intended for the following users:

- Network Planners
- On-site technical support and maintenance personnel
- Network administrators responsible for network configuration and maintenance

© 2011-2022 Xiamen Milesight IoT Co., Ltd.

All rights reserved.

All information in this user guide is protected by copyright law. Whereby, no organization or individual shall copy or reproduce the whole or part of this user guide by any means without written authorization from Xiamen Milesight IoT Co., Ltd.

Related Documents

Document	Description
UR32L Datasheet	Datasheet for the UR32L industrial cellular router.
UR32L Quick Start Guide	Quick Installation guide for the UR32L industrial cellular router.

Declaration of Conformity

UR32L is in conformity with the essential requirements and other relevant provisions of the CE, FCC, and RoHS.



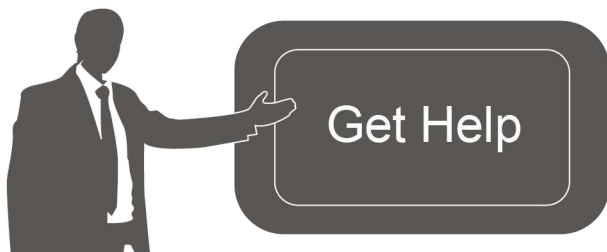

For assistance, please contact
Milesight technical support:
Email: iot.support@milesight.com
Tel: 86-592-5085280
Fax: 86-592-5023065
Address: Building C09, Software Park III,
Xiamen 361024, China

Revision History

Date	Doc Version	Description
Mar. 23, 2021	V 1.0	Initial version
Sept. 17, 2021	V 1.1	<ol style="list-style-type: none">1. Cellular and ping detection support IPv62. Add WAN connection type: DHCPv6 client, DS-Lite3. Add DHCPv6 Server feature4. Add IPv6 static routing feature5. Add Expert Option box in IPsec settings6. Support SMS inbox and outbox record clear

Contents

Chapter 1 Product Introduction.....	7
1.1 Overview.....	7
1.2 Advantages.....	7
1.3 Specifications.....	8
1.4 Dimensions.....	10
Chapter 2 Access to Web GUI.....	11
Chapter 3 Web Configuration.....	13
3.1 Status.....	13
3.1.1 Overview.....	13
3.1.2 Cellular.....	14
3.1.3 Network.....	15
3.1.4 VPN.....	16
3.1.5 Routing.....	17
3.1.6 Host List.....	18
3.2 Network.....	19
3.2.1 Interface.....	19
3.2.1.1 Link Failover.....	19
3.2.1.2 Cellular.....	21
3.2.1.3 Port.....	23
3.2.1.4 WAN.....	24
3.2.1.5 Bridge.....	29
3.2.1.6 Switch.....	29
3.2.1.7 Loopback.....	30
3.2.2 DHCP.....	31
3.2.2.1 DHCP Server/DHCPv6 Server.....	31
3.2.2.2 DHCP Relay.....	33
3.2.3 Firewall.....	33
3.2.3.1 Security.....	34
3.2.3.2 ACL.....	35
3.2.3.3 Port Mapping.....	36
3.2.3.4 DMZ.....	37
3.2.3.5 MAC Binding.....	38
3.2.3.6 Custom Rules.....	38
3.2.3.7 SPI.....	39
3.2.4 QoS.....	39
3.2.5 VPN.....	41
3.2.5.1 DMVPN.....	41
3.2.5.2 IPSec Server.....	42
3.2.5.3 IPSec.....	46
3.2.5.4 GRE.....	48
3.2.5.5 L2TP.....	49
3.2.5.6 PPTP.....	51

3.2.5.7 OpenVPN Client.....	53
3.2.5.8 OpenVPN Server.....	54
3.2.5.9 Certifications.....	56
3.2.6 IP Passthrough.....	59
3.2.7 Routing.....	59
3.2.7.1 Static Routing.....	59
3.2.7.2 RIP.....	60
3.2.7.3 OSPF.....	63
3.2.7.4 Routing Filtering.....	69
3.2.8 VRRP.....	69
3.2.9 DDNS.....	71
3.3 System.....	73
3.3.1 General Settings.....	73
3.3.1.1 General.....	73
3.3.1.2 System Time.....	74
3.3.1.3 Email.....	75
3.3.2 Phone&SMS.....	77
3.3.2.1 Phone.....	77
3.3.2.2 SMS.....	78
3.3.3 User Management.....	80
3.3.3.1 Account.....	80
3.3.3.2 User Management.....	81
3.3.4 SNMP.....	81
3.3.4.1 SNMP.....	81
3.3.4.2 MIB View.....	82
3.3.4.3 VACM.....	83
3.3.4.4 Trap.....	84
3.3.4.5 MIB.....	84
3.3.5 AAA.....	85
3.3.5.1 Radius.....	85
3.3.5.2 TACACS+.....	85
3.3.5.3 LDAP.....	86
3.3.5.4 Authentication.....	87
3.3.6 Device Management.....	88
3.3.6.1 DeviceHub.....	88
3.3.6.2 Milesight VPN.....	88
3.3.7 Events.....	89
3.3.7.1 Events.....	90
3.3.7.2 Events Settings.....	90
3.4 Maintenance.....	92
3.4.1 Tools.....	92
3.4.1.1 Ping.....	92
3.4.1.2 Traceroute.....	93
3.4.1.3 Packet Analyzer.....	93

3.4.1.4 Qxdmlog.....	94
3.4.2 Debugger.....	94
3.4.2.1 Cellular Debugger.....	94
3.4.2.2 Firewall Debugger.....	95
3.4.3 Log.....	95
3.4.3.1 System Log.....	95
3.4.3.2 Log Download.....	96
3.4.3.3 Log Settings.....	97
3.4.4 Upgrade.....	98
3.4.5 Backup and Restore.....	98
3.4.6 Reboot.....	99
Chapter 4 Application Examples.....	100
4.1 Restore Factory Defaults.....	100
4.1.1 Via Web Interface.....	100
4.2.2 Via Hardware.....	101
4.2 Firmware Upgrade.....	101
4.3 Events Application Example.....	102
4.4 SNMP Application Example.....	103
4.5 Network Connection.....	106
4.5.1 Cellular Connection.....	106
4.5.2 Ethernet WAN Connection.....	108
4.6 VRRP Application Example.....	109
4.7 NAT Application Example.....	113
4.8 Access Control Application Example.....	113
4.9 QoS Application Example.....	115
4.10 PPTP Application Example.....	116

Chapter 1 Product Introduction

1.1 Overview

UR32L is an industrial cellular router with embedded intelligent software features that are designed for multifarious M2M/IoT applications. Supporting global WCDMA and 4G LTE, UR32L provides drop-in connectivity for operators and makes a giant leap in maximizing uptime.

Adopting high-performance and low-power consumption industrial grade CPU and wireless module, the UR32L is capable of providing wire-speed network with low power consumption and ultra-small package to ensure the extremely safe and reliable connection to the wireless network.

UR32L is particularly ideal for smart grid, digital media installations, industrial automation, telemetry equipment, medical device, digital factory, finance, payment device, environment protection, water conservancy and so on.

For details of hardware and installation, please check UR32L Quick Start Guide.

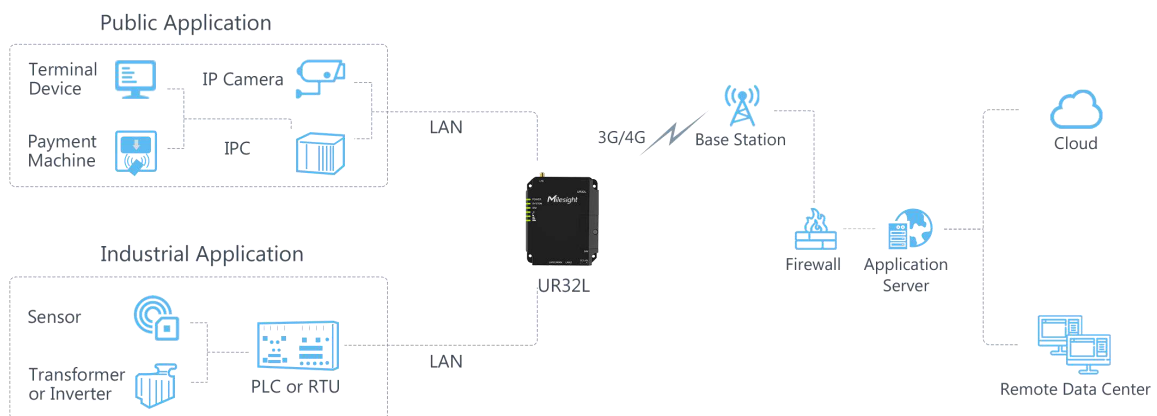

Figure 1-1

1.2 Advantages

Benefits

- Built-in industrial strong NXP CPU, big memory
- Fast Ethernets for fast data transmission
- Rugged enclosure, optimized for DIN rail or shelf mounting
- 3-year warranty included

Security & Reliability

- Automated failover/failback between Ethernet and Cellular (dual SIM)
- Enable unit with security frameworks like IPsec/OpenVPN/GRE/L2TP/PPTP/ DMVPN
- Embed hardware watchdog, automatically recovering from various failure, and ensuring highest level of availability

- Establish a secured mechanism on centralized authentication and authorization of device access by supporting AAA (TACACS+, Radius, LDAP, local authentication) and multiple levels of user authority

Easy Maintenance

- Milesight DeviceHub provides easy setup, mass configuration, and centralized management of remote devices
- The user-friendly web interface design and more than one option of upgrade help administrator to manage the device as easy as pie
- Web GUI and CLI enable the admin to achieve simple management and quick configuration among a large quantity of devices
- Efficiently manage the remote routers on the existing platform through the industrial standard SNMP

Capabilities

- Link remote devices in an environment where communication technologies are constantly changing
- Industrial 32-bit ARM Cortex-A7 processor, high-performance operating up to 528MHz and 128 MB memory available to support more applications
- Support rich protocols like SNMP, Modbus bridging, RIP, OSPF
- Support wide operating temperature ranging from -40°C to 70°C/-40°F to 158°F

1.3 Specifications

Hardware System	
CPU	528MHz, 32-bit ARM Cortex-A7
Memory	128 MB Flash, 128 MB DDR3 RAM
Cellular Interfaces	
Connectors	1 × 50 Ω SMA (Center pin: SMA Female)
SIM Slots	1 (Mini SIM-2FF)
Ethernet	
Ports	2 × RJ-45 (PoE PSE Optional)
Physical Layer	10/100 Base-T (IEEE 802.3)
Data Rate	10/100 Mbps (auto-sensing)
Interface	Auto MDI/MDIX
Mode	Full or half duplex (auto-sensing)

Software

Network Protocols	IPv4/IPv6, PPP, PPPoE, SNMP v1/v2c/v3, TCP, UDP, DHCP, RIPv1/v2, OSPF, DDNS, VRRP, HTTP, HTTPS, DNS, ARP, QoS, SNMP, Telnet, VLAN, SSH, etc.
VPN Tunnel	DMVPN/IPsec/OpenVPN/PPTP/L2TP/GRE
Access Authentication	CHAP/PAP/MS-CHAP/MS-CHAPV2
Firewall	ACL/DMZ/Port Mapping/MAC Binding/SPI/DoS&DDoS Protection /IP Passthrough
Management	Web, CLI, SMS, On-demand dial up, DeviceHub
AAA	Radius, TACACS+, LDAP, Local Authentication
Multilevel Authority	Multiple levels of user authority
Reliability	VRRP, WAN Failover

Power Supply and Consumption

Connector	2-pin with 5.08 mm terminal block
Input Voltage	9-48 VDC
Power Consumption	Typical 1.8 W, Max 2.2 W (In Non-PoE mode)
Power Output	2 × 802.3 af/at PoE output

Physical Characteristics

Ingress Protection	IP30
Housing	Metal
Dimensions	108 x 90 x 26 mm (4.25 x 3.54 x 1.02 in)
Mounting	Desktop, wall or DIN rail mounting

Others

Reset Button	1 × RESET
LED Indicators	1 × POWER, 1 × SYSTEM, 1 × SIM, 3 × Signal strength
Built-in	Watchdog, Timer

Environmental

Operating Temperature	-40°C to +70°C (-40°F to +158°F) Reduced cellular performance above 60°C
Storage Temperature	-40°C to +85°C (-40°F to +185°F)
Ethernet Isolation	1.5 kV RMS
Relative Humidity	0% to 95% (non-condensing) at 25°C/77°F

1.4 Dimensions (mm)

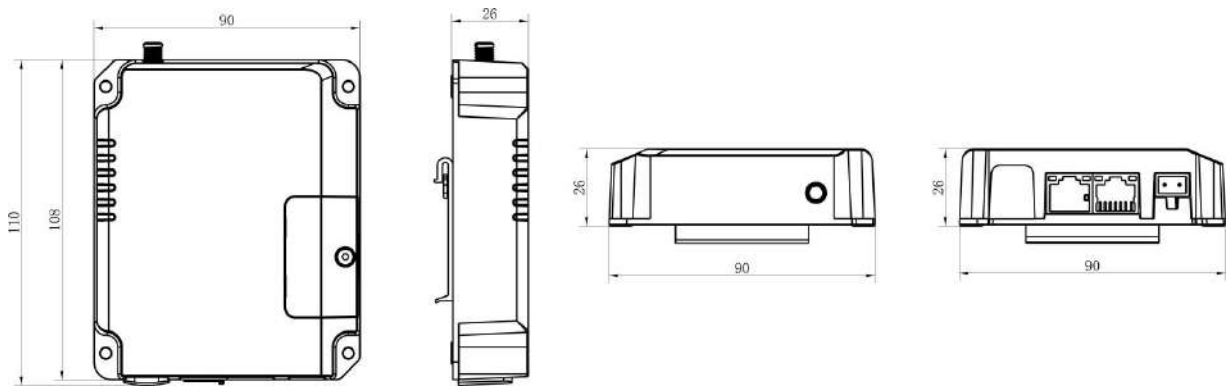

Figure 1-2

Chapter 2 Access to Web GUI

This chapter explains how to access to Web GUI of the UR32L router. Connect PC to LAN port of UR32L router directly. The following steps are based on Windows 10 operating system for your reference.

Username: **admin**

Password: **password**

IP Address: **192.168.1.1**

1. Go to “Control Panel” → “Network and Internet” → “Network and Sharing Center”, then click “Ethernet” (May have different names).

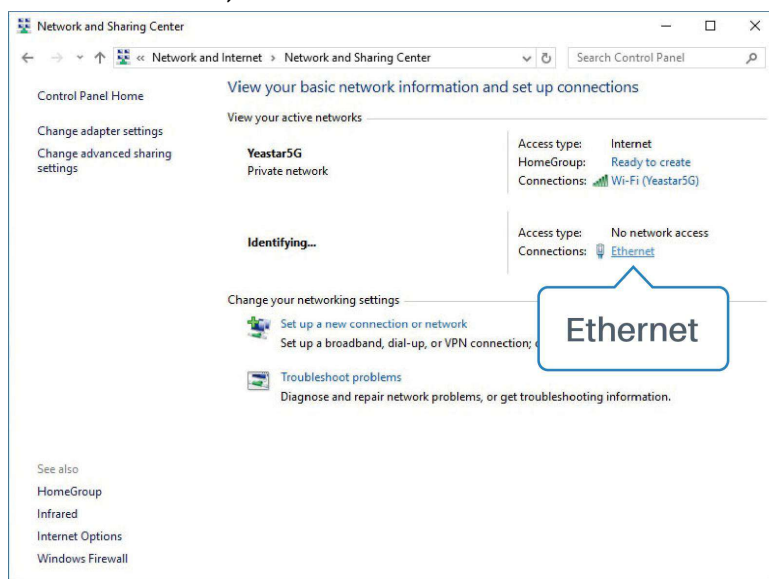

2. Go to “Properties” → “Internet Protocol Version 4(TCP/IPv4)”, select “Obtain an IP address automatically” or “Use the following IP address”, then assign a static IP manually within the same subnet of the device.

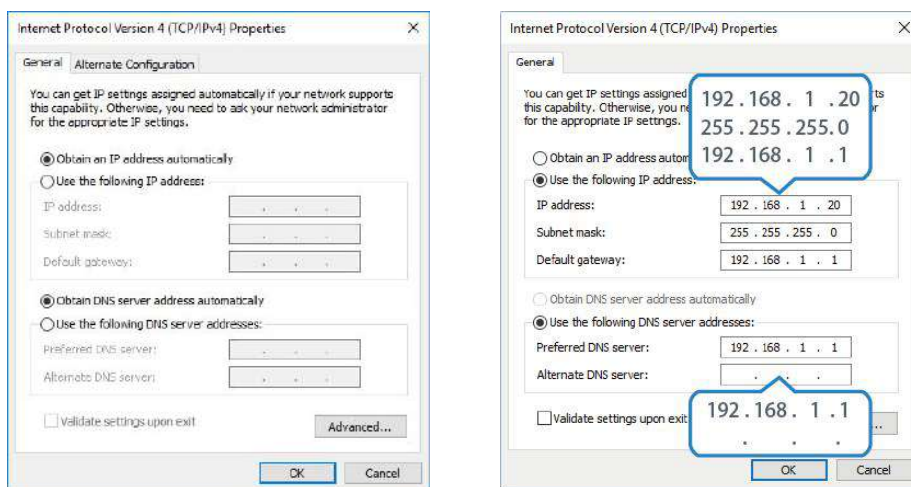

3. Open a Web browser on your PC (Chrome is recommended), type in the IP address 192.168.1.1, and press Enter on your keyboard.

4. Enter the username, password, and click "Login".



The login page features the Milesight logo at the top center. In the top right corner, there is a globe icon and the text "English". Below the logo, there are two input fields: "Username" with a person icon and "Password" with a lock icon. A blue "Login" button is positioned below these fields.

! If you enter the username or password incorrectly more than 5 times, the login page will be locked for 10 minutes.

5. When you login with the default username and password, you will be asked to modify the password. It's suggested that you change the password for the sake of security. Click "Cancel" button if you want to modify it later.

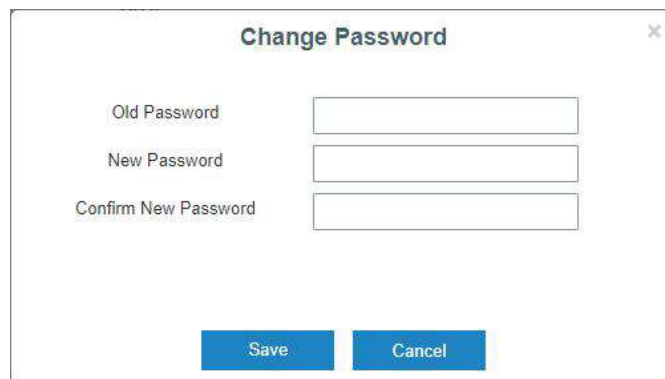

The "Change Password" dialog box contains three input fields: "Old Password", "New Password", and "Confirm New Password". At the bottom, there are two buttons: "Save" and "Cancel".

6. After you login the Web GUI, you can view system information and perform configuration on the router.

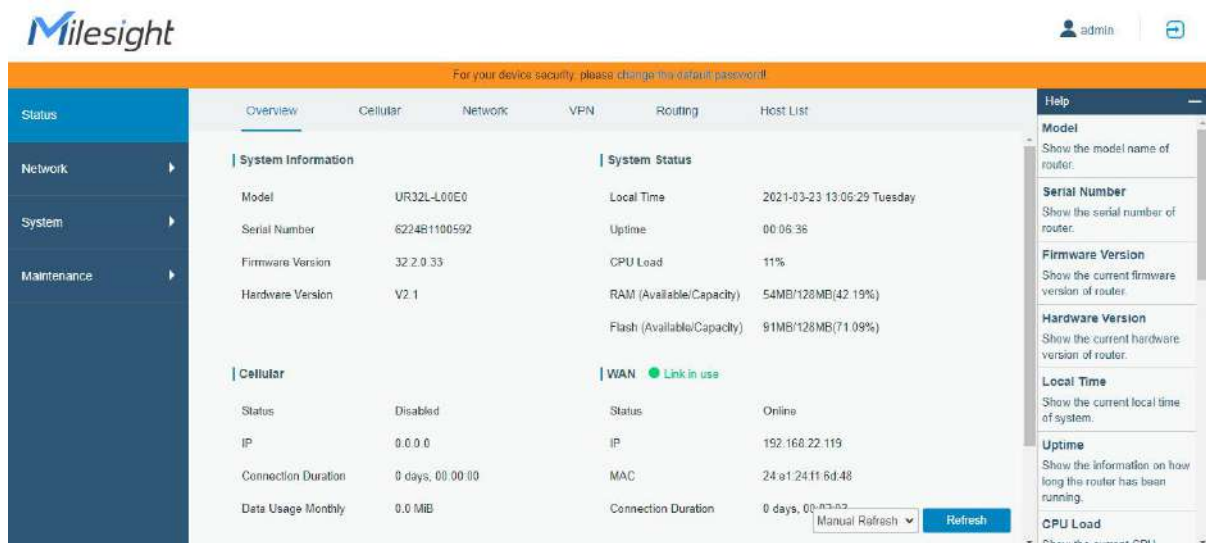

The Milesight Web GUI dashboard displays system information and status. At the top, there is a notification: "For your device security, please change the default password!". The dashboard is divided into several sections:

- System Information:**

Model	UR32L-L00E0
Serial Number	6234B1100592
Firmware Version	32.2.0.33
Hardware Version	V2.1
- System Status:**

Local Time	2021-03-23 13:06:29 Tuesday
Uptime	00:06:36
CPU Load	11%
RAM (Available/Capacity)	54MB/128MB(42.19%)
Flash (Available/Capacity)	91MB/128MB(71.09%)
- Cellular:**

Status	Disabled
IP	0.0.0.0
Connection Duration	0 days, 00:00:00
Data Usage Monthly	0.0 MB
- WAN:** Link in use. Status: Online. IP: 192.168.22.119. MAC: 24:91:24:11:8d:48. Connection Duration: 0 days, 00:00:00.

On the right side, there is a "Help" sidebar with expandable sections for Model, Serial Number, Firmware Version, Hardware Version, Local Time, Uptime, and CPU Load.

Chapter 3 Web Configuration

3.1 Status

3.1.1 Overview

You can view the system information of the router on this page.

Overview	Cellular	Network	VPN	Routing	Host List
System Information			System Status		
Model	UR32L-L04EU		Local Time	2021-09-17 08:27:58 Friday	
Serial Number	6224B2227522		Uptime	00:01:38	
Firmware Version	32.3.0.2		CPU Load	17%	
Hardware Version	V3.0		RAM (Available/Capacity)	48MB/128MB(37.5%)	
			Flash (Available/Capacity)	90MB/128MB(70.31%)	
Cellular ● Link in use			WAN		
Status	Ready, TDD LTE, 		Status	Offline	
IPv4	10.15.114.165/30		IPv4	192.168.22.212	
IPv6	fe80::c4c:e5ff:fe53:3776/64		IPv6	fe80::26e1:24ff:fe1:f741/64	
Connection Duration	0 days, 00:00:16		MAC	24:e1:24:f1:f7:43	
Data Usage Monthly	0.2 MIB		Connection Duration	0 days, 00:00:00	
LAN					
IPv4	192.168.1.1				
IPv6	7171::1/64				
Connected Devices	1				

Figure 3-1-1-1

System Information	
Item	Description
Model	Show the model name of router.
Serial Number	Show the serial number of router.
Firmware Version	Show the currently firmware version of router.
Hardware Version	Show the currently hardware version of router.

Table 3-1-1-1 System Information

System Status	
Item	Description
Local Time	Show the currently local time of system.
Uptime	Show the information on how long the router has been running.
CPU Load	Show the current CPU utilization of the router.
RAM (Available/Capacity)	Show the RAM capacity and the available RAM memory.
Flash (Available/Capacity)	Show the Flash capacity and the available Flash memory.

Table 3-1-1-2 System Status

Cellular	
Item	Description
Status	Show the real-time status of the currently SIM card
IPv4/IPv6	Show the IPv4/IPv6 address obtained from the mobile carrier.
Connection Duration	Show the connection duration of the currently SIM card.
Data Usage Monthly	Show the monthly data usage statistics of currently used SIM card.

Table 3-1-1-3 Cellular Status

WAN	
Item	Description
Status	Show the currently status of WAN port.
IPv4/IPv6	The IPv4/IPv6 address configured WAN port.
MAC	The MAC address of the Ethernet port.
Connection Duration	Show the connection duration of the WAN port.

Table 3-1-1-4 WAN Status

LAN	
Item	Description
IP4/IPv6	Show the IP4/IPv6 address of the LAN port.
Connected Devices	Number of devices that connected to the router's LAN.

Table 3-1-1-5 LAN Status

3.1.2 Cellular

You can view the cellular network status of router on this page.

Overview	Cellular	Network	VPN	Routing	Host List
Modem		Network			
Model	EC25	Status	Connected		
Version	EC25EUXGAR08A05M1G	IPv4 Address	10.142.57.34/30		
Signal Level	23asu (-67dBm)	IPv4 Gateway	10.142.57.33		
Register Status	Registered (Home network)	IPv4 DNS	211.136.17.107		
IMEI	862506043707416	IPv6 Address	fe80::cca3:25ff:fed2:908/64		
IMSI	460081370507437	IPv6 Gateway	::		
ICCID	89860493262190157437	IPv6 DNS	::		
ISP	CHINA MOBILE	Connection Duration	0 days, 00:00:04		
Network Type	TDD LTE	Data Usage Monthly			
PLMN ID	46000	RX	0.0 MiB		
LAC	592f	TX	0.0 MiB		
Cell ID	ceb972a	ALL	0.0 MiB		

Figure 3-1-2-1

Modem Information	
Item	Description
Status	Show corresponding detection status of module and SIM card.
Version	Show the cellular module firmware version.
Signal Level	Show the cellular signal level.
Register Status	Show the registration status of SIM card.
IMEI	Show the IMEI of the module.
IMSI	Show IMSI of the SIM card.
ICCID	Show ICCID of the SIM card.
ISP	Show the network provider which the SIM card registers on.
Network Type	Show the connected network type, such as LTE, 3G, etc.
PLMN ID	Show the current PLMN ID, including MCC, MNC, LAC and Cell ID.
LAC	Show the location area code of the SIM card.
Cell ID	Show the Cell ID of the SIM card location.

Table 3-1-2-1 Modem Information

Network	
Item	Description
Status	Show the connection status of cellular network.
IPv4/IPv6 Address	Show the IPv4/IPv6 address and netmask of cellular network.
IPv4/IPv6 Gateway	Show the IPv4/IPv6 gateway and netmask of cellular network.
IPv4/IPv6 DNS	Show the IPv4/IPv6 DNS of cellular network.
Connection Duration	Show information on how long the cellular network has been connected.

Table 3-1-2-2 Network Status

Data Usage Monthly	
Item	Description
RX	Show the monthly rx data usage statistics of SIM.
TX	Show the monthly tx data usage statistics of SIM.
ALL	Show the monthly all data usage statistics of SIM.

Table 3-1-2-3 Data Usage Information

3.1.3 Network

On this page you can check the WAN and LAN status of the router.

WAN-IPv4						
Port	Status	Type	IPv4	Gateway	DNS	Connection Duration
LAN1/WAN	up	Static	192.168.22.2/24	192.168.22.1	114.114.114.114	08h 32m 53s
WAN-IPv6						
Port	Status	Type	IPv6	Gateway	DNS	Connection Duration
LAN1/WAN	up	Static	fe80::26e1:24ff:fe17:2fea/64	-	-	08h 32m 53s

Figure 3-1-3-1

WAN Status

Item	Description
Port	Show the name of WAN port.
Status	Show the status of WAN port. "up" refers to a status that WAN is enabled and Ethernet cable is connected. "down" means Ethernet cable is disconnected or WAN function is disabled.
Type	Show the dial-up connection type of WAN port.
IPv4/IPv6	Show the IPv4 address with netmask or IPv6 address with prefix-length of WAN port.
Gateway	Show the gateway of WAN port.
DNS	Show the DNS of WAN port.
Connection Duration	Show the information on how long the Ethernet cable has been connected on WAN port when WAN function is enabled. Once WAN function is disabled or Ethernet connection is disconnected, the duration will stop.

Table 3-1-3-1 WAN Status

Bridge				
Name	STP	IPv4	IPv6	Members
Bridge0	Disabled	192.168.219.1/24	7878::1/64	vlan 1,WLAN

Figure 3-1-3-2

Bridge	
Item	Description
Name	Show the name of the bridge interface.
STP	Show if STP is enabled.
IPv4/IPv6	Show the IPv4/IPv6 address and netmask of the bridge interface.
Netmask	Show the Netmask of the bridge interface.
Members	Show the members of the bridge interface.

Table 3-1-3-2 Bridge Status

3.1.4 VPN

You can check VPN status on this page, including PPTP, L2TP, IPsec, OpenVPN and DMVPN.

Overview	Cellular	Network	VPN	Routing	Host List
Clients					
Name	Status	Local IP	Remote IP		
l2tp_1	Disconnected	-	-		
Server					
Name	Status				
OpenVPN Server	Disabled				
Ipsec Server	Disabled				
Connected List					
Server Type	Client IP	Duration			

Figure 3-1-4-1

VPN Status	
Item	Description
Clients	
Name	Show the name of the enabled VPN clients.
Status	Show the status of client. "Connected" refers to a status that client is connected to the server. "Disconnected" means client is disconnected to the server.
Local IP	Show the local IP address of the tunnel.
Remote IP	Show the real remote IP address of the tunnel.
Server	
Name	Show the name of the enabled VPN Server.
Status	Show the status of Server.
Connected List	
Server Type	Show the type of the server.
Client IP	Show the IP address of the client which connected to the server.
Duration	Show the information about how long the client has been connected to this server when the server is enabled. Once the server is disabled or connection is disconnected, the duration will stop counting.

Table 3-1-4-1 VPN Status

3.1.5 Routing

You can check routing status on this page, including the routing table and ARP cache.

Overview	Cellular	Network	VPN	Routing	Host List
Routing Table					
Destination	Netmask/Prefix Length	Gateway	Interface	Metric	
0.0.0.0	0.0.0.0	10.142.57.33	Cellular 0	1	
8.8.8.8	255.255.255.255	192.168.22.1	LAN1/WAN	1	
8.8.8.8	255.255.255.255	10.142.57.33	Cellular 0	-	
10.142.57.32	255.255.255.252	-	Cellular 0	-	
114.114.114.114	255.255.255.255	192.168.22.1	LAN1/WAN	1	
114.114.114.114	255.255.255.255	10.142.57.33	Cellular 0	-	
127.0.0.0	255.0.0.0	-	Loopback	-	
192.168.1.0	255.255.255.0	-	Bridge0	-	
192.168.22.0	255.255.255.0	-	LAN1/WAN	-	
211.136.17.107	255.255.255.255	10.142.57.33	Cellular 0	1	
211.136.20.203	255.255.255.255	10.142.57.33	Cellular 0	1	
::1	128	-	Loopback	-	
7171::	64	-	Bridge0	-	
ARP Cache					
IP	MAC	Interface			
8.8.8.8	00:00:00:00:00:00	LAN1/WAN			
192.168.22.1	00:00:00:00:00:00	LAN1/WAN	Manual Refresh	Refresh	

Figure 3-1-5-1

Item	Description
Routing Table	
Destination	Show the IP address of destination host or destination network.
Netmask/Prefix Length	Show the netmask or prefix length of destination host or destination network.
Gateway	Show the IP address of the gateway.
Interface	Show the outbound interface of the route.
Metric	Show the metric of the route.
ARP Cache	
IP	Show the IP address of ARP pool.
MAC	Show the IP address's corresponding MAC address.
Interface	Show the binding interface of ARP.

Table 3-1-5-1 Routing Information

3.1.6 Host List

You can view the host information on this page.

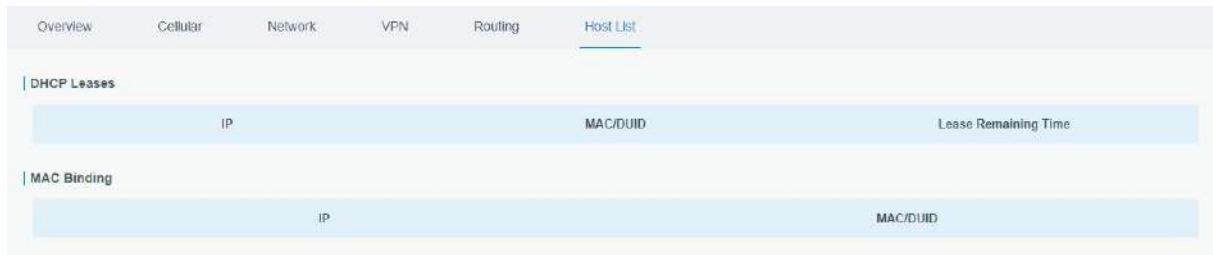

Figure 3-1-6-1

Host List	
Item	Description
DHCP Leases	
IP Address	Show IP address of DHCP client
MAC/DUID	Show MAC address of DHCPv4 client or DUID of DHCPv6 client.
Lease Time Remaining	Show the remaining lease time of DHCP client.
MAC Binding	
IP & MAC	Show the IP address and MAC address set in the Static IP list of DHCP service.

Table 3-1-6-1 Host List Description

3.2 Network

3.2.1 Interface

3.2.1.1 Link Failover

This section describes how to configure link failover strategies, their priority and the ping settings, each rule owns its own ping rules by default. Router will follow the priority to choose the next available interface to access the internet, make sure you have enable the full interface that you need to use here. If priority 1 can only use IPv4, UR32L will select a second link which IPv6 works as main IPv6 link and vice versa.

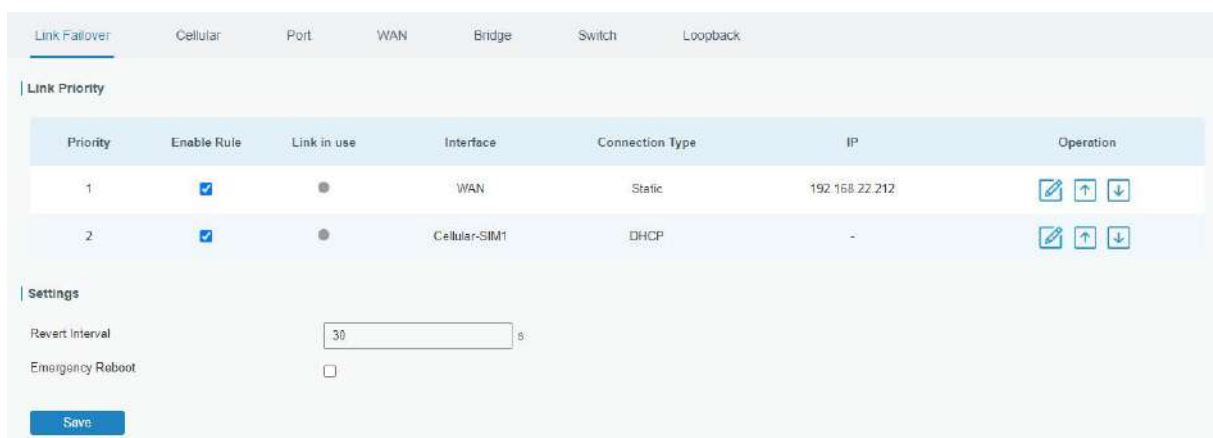

Figure 3-2-1-1

Link Failover	
Item	Description
Link Priority	
Priority	Display the priority of each interface, you can modify it by the operation's up and down button.
Enable Rule	If enabled, the router will choose this interface into its switching rule. For the Cellular interface, if it's not enabled here, the interface will be disabled as well.
Link In Use	Mark whether this interface is in use with Green color
Interface	Display the name of the interface.
Connection type	Display how to obtain the IP address in this interface, like static IP or DHCP.
IP	Display the IP address of the interface.
Operation	You can change the priority of the rules and configure the ping detection rules here.
Settings	
Revert Interval	Specify the number of seconds to waiting for switching to the link with higher priority, 0 means disable the function.
Emergency Reboot	Enable to reboot the device if no link is available.

Table 3-2-1-1 Link Failover Parameters

Ping Detection [X]

Enable

IPv4 Primary Server

IPv4 Secondary Server

IPv6 Primary Server

IPv6 Secondary Server

Interval s

Retry Interval s

Timeout s

Max Ping Retries

OK Cancel

Figure 3-2-1-2

Ping Detection	
Item	Description
Enable	If enabled, the router will periodically detect the connection status of the link.
IPv4/IPv6 Primary	The router will send ICMP packet to the IPv4/IPv6 address

Server	or hostname to determine whether the Internet connection is still available or not.
IPv4/IPv6 Secondary Server	The router will try to ping the secondary server name if primary server is not available.
Interval	Time interval (in seconds) between two Pings.
Retry Interval	Set the ping retry interval. When ping failed, the router will ping again in every retry interval.
Timeout	The maximum amount of time the router will wait for a response to a ping request. If it does not receive a response for the amount of time defined in this field, the ping request will be considered to have failed.
Max Ping Retries	The retry times of the router sending ping request until determining that the connection has failed.

Table 3-2-1-2 Ping Detection Parameters

3.2.1.2 Cellular

This section explains how to set the related parameters for cellular network.

The screenshot displays the 'Cellular' configuration page with the following settings:

- Cellular Settings**
 - Protocol Type: IPv4/IPv6
 - APN: [Empty]
 - Username: [Empty]
 - Password: [Empty]
 - PIN Code: [Empty]
 - Access Number: [Empty]
 - Authentication Type: Auto
 - Network Type: Auto
 - PPP Preferred:
 - SMS Center: [Empty]
 - Enable NAT:
 - Roaming:
 - Data Limit: 0 MB
 - Billing Day: Day 1 of The Month
- Connection Setting**
 - Connection Mode: Always Online
 - Re-dial Interval(s): 5

Figure 3-2-1-3

Cellular Settings	
Item	Description
Protocol	Select from "IPv4", "IPv6" and "IPv4/IPv6".
APN	Enter the Access Point Name for cellular dial-up connection provided by local ISP.
Username	Enter the username for cellular dial-up connection provided by local ISP.
Password	Enter the password for cellular dial-up connection provided by local ISP.
PIN Code	Enter a 4-8 characters PIN code to unlock the SIM.
Access Number	Enter the dial-up center NO. For cellular dial-up connection provided by local ISP.
Authentication Type	Select from "Auto", "PAP", "CHAP", "MS-CHAP", and "MS-CHAPv2".
Network Type	Select from "Auto", "4G Only", "3G Only", and "2G Only". Auto: connect to the network with the strongest signal automatically. 4G Only: connect to 4G network only. And so on.
PPP Preferred	The PPP dial-up method is preferred.
SMS Center	Enter the local SMS center number for storing, forwarding, converting and delivering SMS message.
Enable NAT	Enable or disable NAT function.
Roaming	Enable or disable roaming.
Data Limit	When you reach the specified data usage limit, the data connection of currently used SIM card will be disabled. 0 means disable the function.
Billing Day	Choose the billing day of the SIM card, the router will reset the data used to 0.

Table 3-2-1-3 Cellular Parameters

Connection Setting

Connection Mode Connect on Demand ▼

Re-dial Interval(s) 5

Max Idle Time(s) 60

Triggered by Call

Call Group ▼

Triggered by SMS

SMS Group ▼

SMS Text

Figure 3-2-1-4

Connection Setting	
Item	Description
Connection Mode	Select from "Always Online" and "Connect on Demand".
Re-dial Interval(s)	Set the interval to dial into ISP when it lost connection, the default value is 5s.
Max Idle Times	Set the maximum duration of router when current link is under idle status. Range: 10-3600
Triggered by Call	The router will switch from offline mode to cellular network mode automatically when it receives a call from the specific phone number.
Call Group	Select a call group for call trigger. Go to "System > Phone&SMS > Phone" to set up phone group.
Triggered by SMS	The router will switch from offline mode to cellular network mode automatically when it receives a specific SMS from the specific mobile phone.
SMS Group	Select an SMS group for trigger. Go to "System > Phone&SMS > SMS" to set up SMS group.
SMS Text	Fill in the SMS content for triggering.

Table 3-2-1-4 Cellular Parameters

Related Topics

[Cellular Network Connection](#)

[Phone Group](#)

3.2.1.3 Port

This section describes how to configure the Ethernet port parameters.

UR32L cellular router supports 2 Fast Ethernet ports.

Port	Status	Property	Speed	Duplex
LAN1/WAN	up	wan	auto	auto
LAN2	up	lan	auto	auto

Figure 3-2-1-5

Port Setting	
Item	Description
Port	Users can define the Ethernet ports according to their needs.
Status	Set the status of Ethernet port; select "up" to enable and "down" to disable.
Property	Show the Ethernet port's type, as a WAN port or a LAN port.
Speed	Set the Ethernet port's speed. The options are "auto", "100 Mbps", and "10 Mbps".

Duplex	Set the Ethernet port's mode. The options are "auto", "full", and "half".
--------	---

Table 3-2-1-5 Port Parameters

3.2.1.4 WAN

WAN port can be connected with Ethernet cable to get Internet access. It supports 5 connection types.

- **Static IP:** configure IP address, netmask and gateway for Ethernet WAN interface.
- **DHCP Client:** configure Ethernet WAN interface as DHCP Client to obtain IP address automatically.
- **PPPoE:** configure Ethernet WAN interface as PPPoE Client.
- **DHCPv6 Client:** configure Ethernet WAN interface as DHCP Client to obtain IPv6 address automatically.
- **Dual-Stack Lite:** use IPv4-in-IPv6 tunneling to send terminal device's IPv4 packet through a tunnel on the IPv6 access network to the ISP.

The screenshot displays the WAN Settings configuration page. The left sidebar contains navigation options: Status, Network (selected), Interface, DHCP, Firewall, QoS, VPN, IP Passthrough, Routing, VRRP, DDNS, System, and Maintenance. The main content area shows the WAN Settings for WAN_1. The settings are as follows:

Setting	Value
Enable	<input checked="" type="checkbox"/>
Port	LAN1/WAN
Connection Type	Static IP
IPv4 Address	192.168.22.212
Netmask	255.255.255.0
IPv4 Gateway	192.168.22.1
IPv6 Address	fe80::26e1:24ff:fe1:f741
Prefix Length	64
IPv6 Gateway	
MTU	1500
IPv4 Primary DNS	114.114.114.114
IPv4 Secondary DNS	
IPv6 Primary DNS	
IPv6 Secondary DNS	
Enable NAT	<input checked="" type="checkbox"/>

Figure 3-2-1-6

WAN Setting		
Item	Description	Default
Enable	Enable WAN function.	Enable

Port	The port that is currently set as WAN port.	WAN
Connection Type	Select from "Static IP", "DHCP Client", "DHCPv6 Client", "Dual-Stack Lite" and "PPPoE".	Static IP
MTU	Set the maximum transmission unit.	1500
IPv4 Primary DNS	Set the primary IPv4 DNS server.	8.8.8.8
IPv4 Secondary DNS	Set the secondary IPv4 DNS server.	-- --
IPv6 Primary DNS	Set the primary IPv6 DNS server.	-- --
IPv6 Secondary DNS	Set the secondary IPv6 DNS server.	-- --
Enable NAT	Enable or disable NAT function. When enabled, a private IP can be translated to a public IP.	Enable

Table 3-2-1-6 WAN Parameters

1. Static IP Configuration

If the external network assigns a fixed IP for the WAN interface, user can select "Static IP" mode.

Figure 3-2-1-7

Static IP		
Item	Description	Default
IPv4 Address	Set the IPv4 address of the WAN port.	192.168.0.1

Netmask	Set the Netmask for WAN port.	255.255.255.0
IPv4 Gateway	Set the gateway for WAN port's IPv4 address.	192.168.0.2
IPv6 Address	Set the IPv6 address which can access Internet.	Generated from Mac address
Prefix-length	Set the IPv6 prefix length to identify how many bits of a Global Unicast IPv6 address are there in network part. For example, in 2001:0DB8:0000:000b::/64, the number 64 is used to identify that the first 64 bits are in network part.	64
IPv6 Gateway	Set the gateway for WAN port's IPv6 address. E.g.2001:DB8:ACAD:4::2.	--
Multiple IP Address	Set the multiple IP addresses for WAN port.	Null

Table 3-2-1-7 Static Parameters

2. DHCP Client/DHCPv6 Client

If the external network has DHCP server enabled and has assigned IP addresses to the Ethernet WAN interface, user can select "DHCP client" mode to obtain IP address automatically.

The screenshot shows the configuration for a DHCP Client. The 'Enable' checkbox is checked. The 'Port' is set to 'LAN1/WAN'. The 'Connection Type' is set to 'DHCP Client'. The 'MTU' is set to '1500'. The 'Use Peer DNS' checkbox is unchecked. The 'IPv4 Primary DNS' is set to '114.114.114.114'. The 'IPv4 Secondary DNS' is set to '8.8.8.8'. The 'Enable NAT' checkbox is checked.

Figure 3-2-1-8

The screenshot shows the configuration for a DHCPv6 Client. The 'Enable' checkbox is checked. The 'Port' is set to 'LAN1/WAN'. The 'Connection Type' is set to 'DHCPv6 Client'. The 'Request IPv6-address' is set to 'None'. The 'Request IPv6-prefix of length' is set to '0-64'. The 'MTU' is set to '1500'. The 'IPv6 Primary DNS' and 'IPv6 Secondary DNS' fields are empty. The 'Enable NAT' checkbox is checked.

Figure 3-2-1-9

DHCP Client	
Item	Description
Use Peer DNS	Obtain peer DNS automatically during PPP dialing. DNS is necessary when visiting domain name.
DHCPv6 Client	
Request IPv6-address	Choose the ways to obtain the IPv6 address from the DHCP Server. Select from try, force, none. Try: The DHCP Server will assign specific address in priority. Force: The DHCP Server assigns specific address only. None: The DHCP Server will randomly assign address. The specific address is relevant to the prefix length of IPv6 address you set.
Request prefix length of IPv6	Set the prefix length of IPv6 address which router is expected to obtain from DHCP Server.

Table 3-2-1-8 DHCP Client Parameters

3. PPPoE

PPPoE refers to a point to point protocol over Ethernet. User has to install a PPPoE client on the basis of original connection way. With PPPoE, remote access devices can get control of each user.

Enable	<input checked="" type="checkbox"/>
Port	LAN1/WAN
Connection Type	PPPoE
Username	<input type="text"/>
Password	<input type="text"/>
Link Detection Interval(s)	60
Max Retries	0
MTU	1500
Use Peer DNS	<input type="checkbox"/>
IPv4 Primary DNS	114.114.114.114
IPv4 Secondary DNS	8.8.8.8
Enable NAT	<input checked="" type="checkbox"/>

Figure 3-2-1-10

PPPoE	
Item	Description
Username	Enter the username provided by your Internet Service Provider (ISP).

Password	Enter the password provided by your Internet Service Provider (ISP).
Link Detection Interval (s)	Set the heartbeat interval for link detection. Range: 1-600.
Max Retries	Set the maximum retry times after it fails to dial up. Range: 0-9.
Use Peer DNS	Obtain peer DNS automatically during PPP dialing. DNS is necessary when visiting domain name.

Table 3-2-1-9 PPPoE Parameters

4. Dual-Stack Lite

Dual-Stack Lite (DS-Lite) uses IPv4-in-IPv6 tunneling to send a subscriber's IPv4 packet through a tunnel on the IPv6 access network to the ISP. The IPv6 packet is decapsulated to recover the subscriber's IPv4 packet and is then sent to the Internet after NAT address and port translation and other LSN related processing. The response packets traverse through the same path to the subscriber.

Enable	<input checked="" type="checkbox"/>
Port	LAN1/WAN
Connection Type	Dual-Stack Lite
IPv6 Gateway	
DS-Lite AFTR Address	
Local IPv6 Address	
MTU	1500
IPv4 Primary DNS	114.114.114.114
IPv4 Secondary DNS	8.8.8.8
IPv6 Primary DNS	
IPv6 Secondary DNS	
Enable NAT	<input checked="" type="checkbox"/>

Figure 3-2-1-11

Dual-Stack Lite	
Item	Description
IPv6 Gateway	Set the gateway for WAN port's IPv6 address.
DS-Lite AFTR Address	Set the DS-Lite AFTR server address.
Local IPv6 Address	Set the WAN port IPv6 address which use the same subnet as IPv6 gateway.

Table 3-2-1-10 Dual-Stack Lite Parameters

Related Configuration Example

[Ethernet WAN Connection](#)

3.2.1.5 Bridge

Bridge setting is used for managing local area network devices which are connected to LAN ports of the UR32L, allowing each of them to access the Internet.

The screenshot shows the 'Bridge Setting' configuration page. At the top, there are tabs for 'Link Failover', 'Cellular', 'Port', 'WAN', 'Bridge', 'Switch', and 'Loopback'. The 'Bridge' tab is selected. Below the tabs, the 'Bridge Setting' section contains the following fields:

- Name: Bridge0
- STP:
- IP Address: 192.168.1.1
- Netmask: 255.255.255.0
- IPv6 Address: 7171::1/64
- MTU: 1500

Below these fields is a section for 'Multiple IP Address' with a table header containing 'IP Address', 'Netmask', and 'Operation'. A blue plus sign (+) is visible at the bottom right of this section, indicating that more IP addresses can be added.

Figure 3-2-1-12

Bridge		
Item	Description	Default
Name	Show the name of bridge. "Bridge0" is set by default and cannot be changed.	Bridge0
STP	Enable/disable STP.	Disable
IP Address	Set the IP address for bridge.	192.168.1.1
Netmask	Set the Netmask for bridge.	255.255.255.0
IPv6 Address	Set the IPv6 address for bridge.	2004::1/64
MTU	Set the maximum transmission unit. Range: 68-1500.	1500
Multiple IP Address	Set the multiple IP addresses for bridge.	Null

Table 3-2-1-11 Bridge Settings

3.2.1.6 Switch

VLAN is a kind of new data exchange technology that realizes virtual work groups by logically dividing the LAN device into network segments.

Figure 3-2-1-13

Switch	
Item	Description
LAN Settings	
Name	Set interface name of VLAN.
VLAN ID	Select VLAN ID of the interface.
IP Address	Set IP address of LAN port.
Netmask	Set Netmask of LAN port.
MTU	Set the maximum transmission unit of LAN port. Range: 68-1500.
VLAN Settings	
VLAN ID	Set the label ID of the VLAN. Range: 1-4094.
LAN 1/2	Make the VLAN bind with the corresponding ports and select status from "Tagged", "Untagged" and "Close" for Ethernet frame on trunk link.
CPU	Control communication between VLAN and other networks.

Table 3-2-1-12 VLAN Trunk Parameters

3.2.1.7 Loopback

Loopback interface is used for replacing router's ID as long as it is activated. When the interface is DOWN, the ID of the router has to be selected again which leads to long convergence time of OSPF. Therefore, Loopback interface is generally recommended as the ID of the router.

Loopback interface is a logic and virtual interface on router. Under default conditions, there's no loopback interface on router, but it can be created as required.

Figure 3-2-1-14

Loopback		
Item	Description	Default
IP Address	Unalterable	127.0.0.1

Netmask	Unalterable	255.0.0.0
Multiple IP Addresses	Apart from the IP above, user can configure other IP addresses.	Null

Table 3-2-1-13 Loopback Parameters

3.2.2 DHCP

DHCP adopts Client/Server communication mode. The Client sends configuration request to the Server which feeds back corresponding configuration information and distributes IP address to the Client so as to achieve the dynamic configuration of IP address and other information.

3.2.2.1 DHCP Server/DHCPv6 Server

UR32L can be set as a DHCP server or DHCPv6 server to distribute IP address when a host logs on and ensures each host is supplied with different IP addresses. DHCP Server has simplified some previous network management tasks requiring manual operations to the largest extent. UR32L only supports stateful DHCPv6 when working as DHCPv6 server.

The screenshot displays the configuration page for a DHCP Server. At the top, there are three tabs: 'DHCP Server', 'DHCPv6 Server', and 'DHCP Relay'. The 'DHCP Server' tab is selected. Below the tabs, the configuration for 'DHCP_Server_1' is shown. The 'Enable' checkbox is checked. The 'Interface' is set to 'Bridge0'. The 'Start Address' is 192.168.1.113, 'End Address' is 192.168.1.126, and 'Netmask' is 255.255.255.0. Other fields include 'Lease Time(Min)' (1440), 'Primary DNS Server' (8.8.8.8), 'Secondary DNS Server' (114.114.114.114), and 'Windows Name Server'. A 'Static IP' section is visible at the bottom with columns for 'MAC Address', 'IP Address', and 'Operation'.

Figure 3-2-2-1

Figure 3-2-2-2

DHCP Server		
Item	Description	Default
Enable	Enable or disable DHCP server.	Enable
Interface	Select interface.	Bridge0
Start Address	Define the beginning of the pool of IP addresses which will be leased to DHCP clients.	192.168.1.100
End Address	Define the end of the pool of IP addresses which will be leased to DHCP clients.	192.168.1.199
Netmask	Define the subnet mask of IPv4 address obtained by DHCP clients from DHCP server.	255.255.255.0
Prefix Length	Set the IPv6 prefix length of IPv6 address obtained by DHCP clients from DHCP server.	64
Lease Time (Min)	Set the lease time on which the client can use the IP address obtained from DHCP server. Range: 1-10080.	1440
Primary DNS Server	Set the primary DNS server.	192.168.1.1
Secondary DNS Server	Set the secondary DNS server.	Null
Windows Name Server	Define the Windows Internet Naming Service obtained by DHCP clients from DHCP sever. Generally you can leave it blank.	Null
Static IP		
MAC Address	Set a static and specific MAC address for the DHCP client (it should be different from other MACs so as to avoid conflict).	Null
DUID	Set a static and specific DUID for the DHCPv6 client (it should be different from other DUID so as to avoid conflict).	Null
IP Address	Set a static and specific IP address for the DHCP client (it	Null

	should be outside of the DHCP range).	
--	---------------------------------------	--

Table 3-2-2-1 DHCP Server Parameters

3.2.2.2 DHCP Relay

UR32L can be set as DHCP Relay to provide a relay tunnel to solve the problem that DHCP Client and DHCP Server are not in the same subnet.

Figure 3-2-3

DHCP Relay	
Item	Description
Enable	Enable or disable DHCP relay.
DHCP Server	Set DHCP server, up to 10 servers can be configured; separate them by blank space or ",".

Table 3-2-2-2 DHCP Relay Parameters

3.2.3 Firewall

This section describes how to set the firewall parameters, including security, ACL, DMZ, Port Mapping, MAC Binding and SPI.

The firewall implements corresponding control of data flow at entry direction (from Internet to local area network) and exit direction (from local area network to Internet) according to the content features of packets, such as protocol style, source/destination IP address, etc. It ensures that the router operate in a safe environment and host in local area network.

3.2.3.1 Security

Security
ACL
Port Mapping
DMZ
MAC Binding
Custom Rules

Prevent Attack

DoS/DDoS Protection

Access Service Control

Service	Port	Local	Remote
HTTP	<input type="text" value="80"/>	<input checked="" type="checkbox"/>	<input checked="" type="checkbox"/>
HTTPS	<input type="text" value="443"/>	<input checked="" type="checkbox"/>	<input checked="" type="checkbox"/>
TELNET	<input type="text" value="23"/>	<input checked="" type="checkbox"/>	<input checked="" type="checkbox"/>
SSH	<input type="text" value="22"/>	<input checked="" type="checkbox"/>	<input checked="" type="checkbox"/>
FTP	<input type="text" value="21"/>	<input type="checkbox"/>	<input checked="" type="checkbox"/>

Website Blocking

URL Blocking

Keyword Blocking

Figure 3-2-3-1

Item	Description	Default
Prevent Attack		
DoS/DDoS Protection	Enable/disable Prevent DoS/DDoS Attack.	Disable
Access Service Control		
Port	Set port number of the services. Range: 1-65535.	--
Local	Access the router locally.	Enable
Remote	Access the router remotely.	Disable
HTTP	Users can log in the device locally via HTTP to access and control it through Web after the option is checked.	80
HTTPS	Users can log in the device locally and remotely via HTTPS to access and control it through Web after option is checked.	443
TELNET	Users can log in the device locally and remotely via Telnet after the option is checked.	23
SSH	Users can log in the device locally and remotely	22

	via SSH after the option is checked.	
FTP	Users can log in the device locally and remotely via FTP after the option is checked.	21
Website Blocking		
URL Blocking	Enter the HTTP address which you want to block.	
Keyword Blocking	You can block specific website by entering keyword. The maximum number of character allowed is 64.	

Table 3-2-3-1 Security Parameters

3.2.3.2 ACL

Access control list, also called ACL, implements permission or prohibition of access for specified network traffic (such as the source IP address) by configuring a series of matching rules so as to filter the network interface traffic. When router receives packet, the field will be analyzed according to the ACL rule applied to the current interface. After the special packet is identified, the permission or prohibition of corresponding packet will be implemented according to preset strategy.

The data package matching rules defined by ACL can also be used by other functions requiring flow distinction.

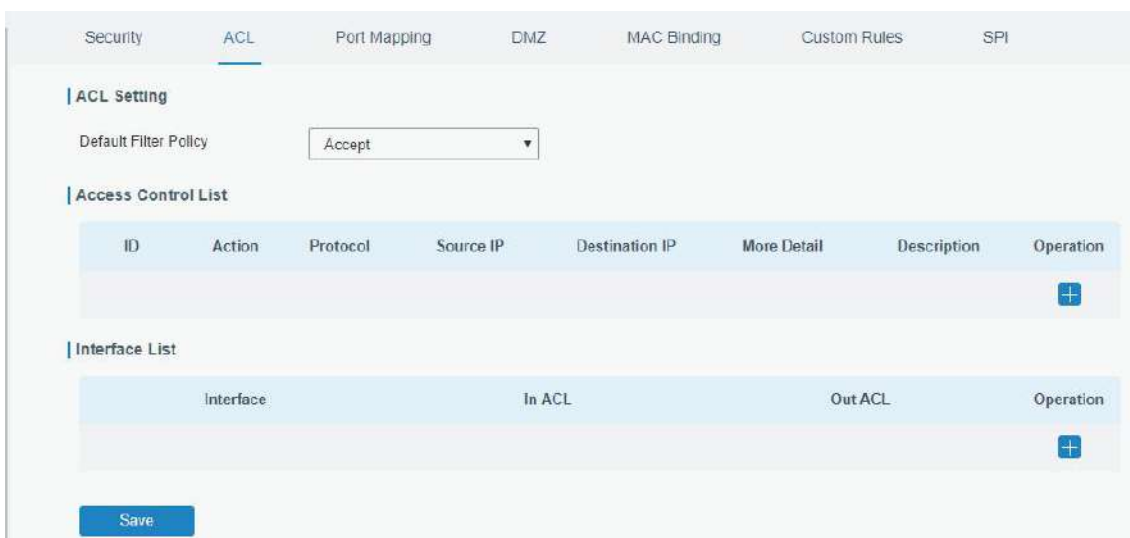

Figure 3-2-3-2

Item	Description
ACL Setting	
Default Filter Policy	Select from "Accept" and "Deny". The packets which are not included in the access control list will be processed by the default filter policy.
Access Control List	
Type	Select type from "Extended" and "Standard".
ID	User-defined ACL number. Range: 1-199.
Action	Select from "Permit" and "Deny".
Protocol	Select protocol from "ip", "icmp", "tcp", "udp", and "1-255".
Source IP	Source network address (leaving it blank means all).

Source Wildcard Mask	Wildcard mask of the source network address.
Destination IP	Destination network address (0.0.0.0 means all).
Destination Wildcard Mask	Wildcard mask of destination address.
Description	Fill in a description for the groups with the same ID.
ICMP Type	Enter the type of ICMP packet. Range: 0-255.
ICMP Code	Enter the code of ICMP packet. Range: 0-255.
Source Port Type	Select source port type, such as specified port, port range, etc.
Source Port	Set source port number. Range: 1-65535.
Start Source Port	Set start source port number. Range: 1-65535.
End Source Port	Set end source port number. Range: 1-65535.
Destination Port Type	Select destination port type, such as specified port, port range, etc.
Destination Port	Set destination port number. Range: 1-65535.
Start Destination Port	Set start destination port number. Range: 1-65535.
End Destination Port	Set end destination port number. Range: 1-65535.
More Details	Show information of the port.
Interface List	
Interface	Select network interface for access control.
In ACL	Select a rule for incoming traffic from ACL ID.
Out ACL	Select a rule for outgoing traffic from ACL ID.

Table 3-2-3-2 ACL Parameters

Related Configuration Example

[Access Control Application Example](#)

3.2.3.3 Port Mapping

Port mapping is an application of network address translation (NAT) that redirects a communication request from the combination of an address and port number to another while the packets are traversing a network gateway such as a router or firewall.

Click  to add a new port mapping rules.



Figure 3-2-3-3

Port Mapping	
Item	Description
Source IP	Specify the host or network which can access local IP address. 0.0.0.0/0 means all.
Source Port	Enter the TCP or UDP port from which incoming packets are forwarded. Range: 1-65535.
Destination IP	Enter the IP address that packets are forwarded to after being received on the incoming interface.
Destination Port	Enter the TCP or UDP port that packets are forwarded to after being received on the incoming port(s). Range: 1-65535.
Protocol	Select from "TCP" and "UDP" as your application required.
Description	The description of this rule.

Table 3-2-3-3 Port Mapping Parameters

Related Configuration Example

[NAT Application Example](#)

3.2.3.4 DMZ

DMZ is a host within the internal network that has all ports exposed, except those forwarded ports in port mapping.

Figure 3-2-3-4

DMZ	
Item	Description
Enable	Enable or disable DMZ.
DMZ Host	Enter the IP address of the DMZ host on the internal network.
Source Address	Set the source IP address which can access to DMZ host. "0.0.0.0/0" means any address.

Table 3-2-3-4 DMZ Parameters

3.2.3.5 MAC Binding

MAC Binding is used for specifying hosts by matching MAC addresses and IP addresses that are in the list of allowed outer network access.

Figure 3-2-3-5

MAC Binding List	
Item	Description
MAC Address	Set the binding MAC address.
IP Address	Set the binding IP address.
Description	Fill in a description for convenience of recording the meaning of the binding rule for each piece of MAC-IP.

Table 3-2-3-5 MAC Binding Parameters

3.2.3.6 Custom Rules

In this page, you can configure your own custom firewall iptables rules.

Figure 3-2-3-6

Custom Rules	
Item	Description
Rule	Specify an iptables rule like the example shows. Tips: You must reboot the device to take effect after modifying or deleting the iptables rules.
Description	Enter the description of the rule.

Table 3-2-3-6 Custom Rules Parameters

3.2.3.7 SPI

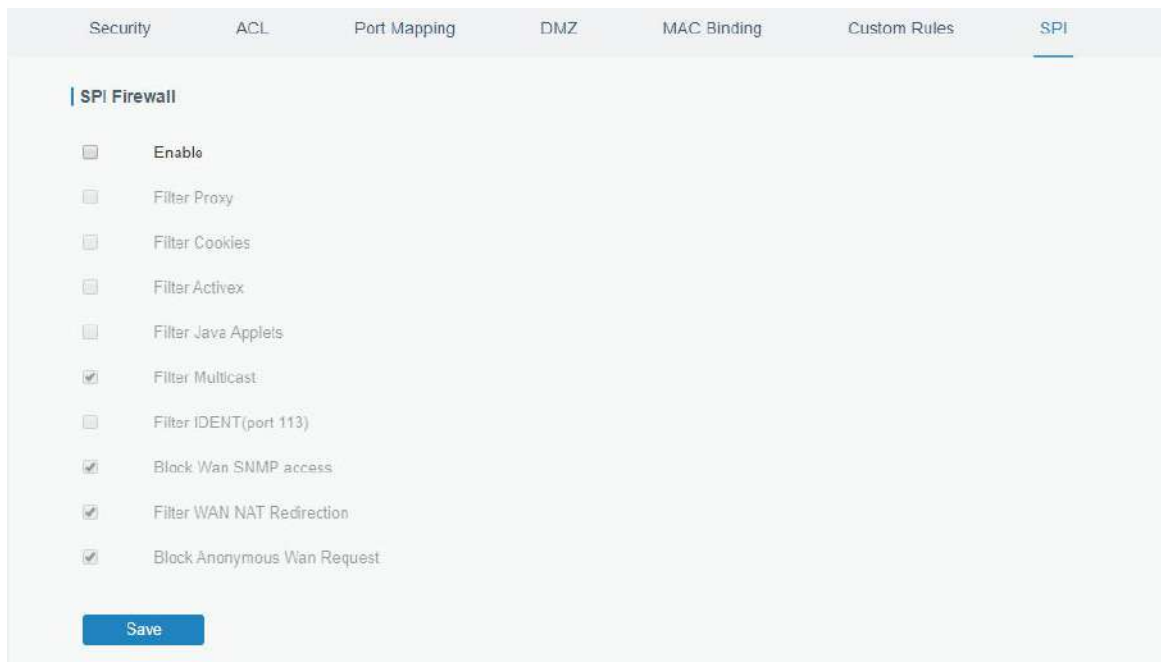

Figure 3-2-3-7

SPI Firewall	
Item	Description
Enable	Enable/disable SPI firewall.
Filter Proxy	Blocks HTTP requests containing the "Host": string.
Filter Cookies	Identifies HTTP requests that contain "Cookie": String and mangle the cookie. Attempts to stop cookies from being used.
Filter ActiveX	Blocks HTTP requests of the URL that ends in ".ocx" or ".cab".
Filter Java Applets	Blocks HTTP requests of the URL that ends in ".js" or ".class".
Filter Multicast	Prevent multicast packets from reaching the LAN.
Filter IDENT(port 113)	Prevent WAN access to Port 113.
Block WAN SNMP access	Block SNMP requests from the WAN.
Filter WAN NAT Redirection	Prevent hosts on LAN from using WAN address of router to connect servers on the LAN (which have been configured using port redirection).
Block Anonymous WAN Requests	Stop the router from responding to "pings" from the WAN.

Table 3-2-3-7 SPI Parameters

3.2.4 QoS

Quality of service (QoS) refers to traffic prioritization and resource reservation control mechanisms rather than the achieved service quality. QoS is engineered to provide different priority for different applications, users, data flows, or to guarantee a certain level of performance to a data flow.

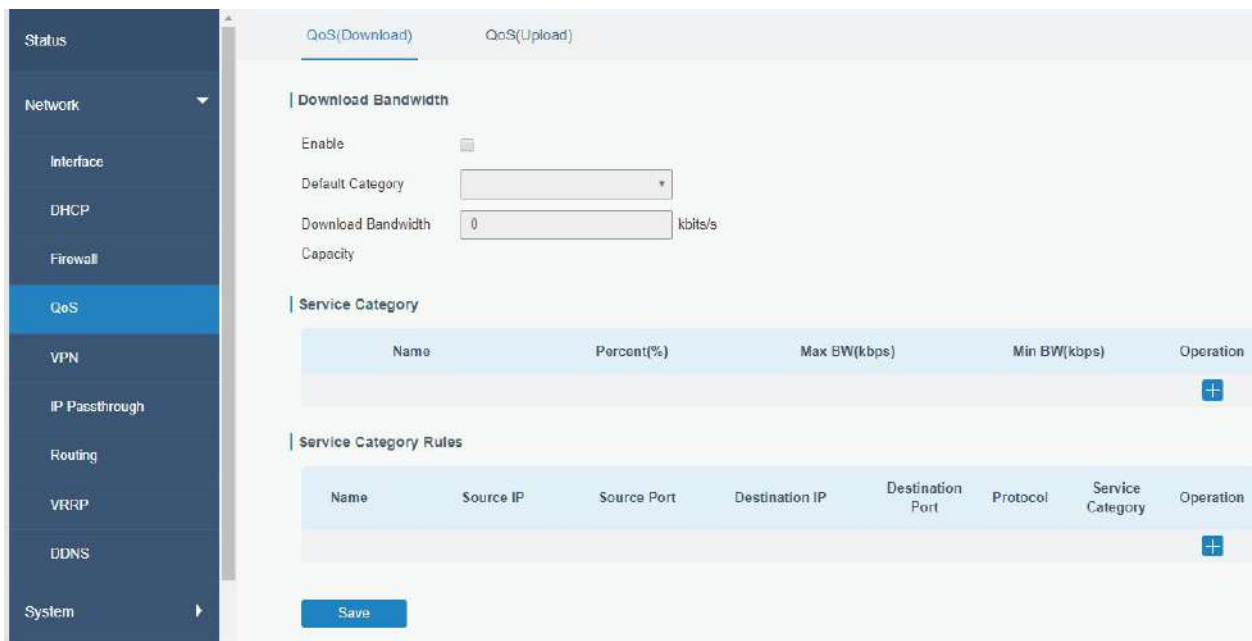

Figure 3-2-4-1

QoS	
Item	Description
Download/Upload	
Enable	Enable or disable QoS.
Default Category	Select the default category from Service Category list.
Download/Upload Bandwidth Capacity	The download/upload bandwidth capacity of the network that the router is connected with, in kbps. Range: 1-8000000.
Service Category	
Name	You can use characters such digits, letters and "-".
Percent (%)	Set percent for the service category. Range: 0-100.
Max BW(kbps)	The maximum bandwidth that this category is allowed to consume, in kbps. The value should be less than the "Download/Upload Bandwidth Capacity" when the traffic is blocked.
Min BW(kbps)	The minimum bandwidth that can be guaranteed for the category, in kbps. The value should be less than the "MAX BW" value.
Service Category Rules	
Item	Description
Name	Give the rule a descriptive name.
Source IP	Source address of flow control (leaving it blank means any).
Source Port	Source port of flow control. Range: 0-65535 (leaving it blank means any).
Destination IP	Destination address of flow control (leaving it blank means

	any).
Destination Port	Destination port of flow control. Range: 0-65535 (leaving it blank means any).
Protocol	Select protocol from "ANY", "TCP", "UDP", "ICMP", and "GRE".
Service Category	Set service category for the rule.

Table 3-2-4-1 QoS (Download/Upload) Parameters

Related Configuration Example

[QoS Application Example](#)

3.2.5 VPN

Virtual Private Networks, also called VPNs, are used to securely connect two private networks together so that devices can connect from one network to the other network via secure channels.

The UR32L supports DMVPN, IPsec, GRE, L2TP, PPTP, OpenVPN, as well as GRE over IPsec and L2TP over IPsec.

3.2.5.1 DMVPN

A dynamic multi-point virtual private network (DMVPN), combining mGRE and IPsec, is a secure network that exchanges data between sites without passing traffic through an organization's headquarter VPN server or router.

Figure 3-2-5-1

DMVPN	
Item	Description
Enable	Enable or disable DMVPN.

Hub Address	The IP address or domain name of DMVPN Hub.
Local IP address	DMVPN local tunnel IP address.
GRE Hub IP Address	GRE Hub tunnel IP address.
GRE Local IP Address	GRE local tunnel IP address.
GRE Netmask	GRE local tunnel netmask.
GRE Key	GRE tunnel key.
Negotiation Mode	Select from "Main" and "Aggressive".
Authentication Algorithm	Select from "DES", "3DES", "AES128", "AES192" and "AES256".
Encryption Algorithm	Select from "MD5" and "SHA1".
DH Group	Select from "MODP768_1", "MODP1024_2" and "MODP1536_5".
Key	Enter the preshared key.
Local ID Type	Select from "Default", "ID", "FQDN", and "User FQDN"
IKE Life Time (s)	Set the lifetime in IKE negotiation. Range: 60-86400.
SA Algorithm	Select from "DES_MD5", "DES_SHA1", "3DES_MD5", "3DES_SHA1", "AES128_MD5", "AES128_SHA1", "AES192_MD5", "AES192_SHA1", "AES256_MD5" and "AES256_SHA1".
PFS Group	Select from "NULL", "MODP768_1", "MODP1024_2" and "MODP1536-5".
Life Time (s)	Set the lifetime of IPsec SA. Range: 60-86400.
DPD Interval Time (s)	Set DPD interval time
DPD Timeout (s)	Set DPD timeout.
Cisco Secret	Cisco Nhrp key.
NHRP Holdtime (s)	The holdtime of NHRP protocol.

Table 3-2-5-1 DMVPN Parameters

3.2.5.2 IPsec Server

IPsec is especially useful for implementing virtual private networks and for remote user access through dial-up connection to private networks. A big advantage of IPsec is that security arrangements can be handled without requiring changes to individual user computers.

IPsec provides three choices of security service: Authentication Header (AH), Encapsulating Security Payload (ESP), and Internet Key Exchange (IKE). AH essentially allows authentication of the senders' data. ESP supports both authentication of the sender and data encryption. IKE is used for cipher code exchange. All of them can protect one and more data flows between hosts, between host and gateway, and between gateways.

The screenshot shows the configuration interface for an IPsec Server. It features a navigation bar with tabs for DMVPN, IPsec Server (active), IPsec, GRE, and L2TP. The main content area is titled 'IPsec Server' and contains several configuration options:

- Enable:** A checkbox that is currently unchecked.
- IPsec Mode:** A dropdown menu set to 'Tunnel'.
- IPsec Protocol:** A dropdown menu set to 'ESP'.
- Local Subnet:** An empty text input field.
- Local Subnet Mask:** An empty text input field.
- Local ID Type:** A dropdown menu set to 'Default'.
- Remote Subnet:** An empty text input field.
- Remote Subnet Mask:** An empty text input field.
- Remote ID Type:** A dropdown menu set to 'Default'.
- IKE Parameter:** An unchecked checkbox.
- SA Parameter:** An unchecked checkbox.
- IPsec Advanced:** A checked checkbox.
- Expert Options:** An empty text input field.

A blue 'Save' button is located at the bottom left of the configuration area.

Figure 3-2-5-2

IPsec Server	
Item	Description
Enable	Enable IPsec tunnel. A maximum of 3 tunnels is allowed.
IPsec Mode	Select from "Tunnel" and "Transport".
IPsec Protocol	Select from "ESP" and "AH".
Local Subnet	Enter the local subnet IP address that IPsec protects.
Local Subnet Netmask	Enter the local netmask that IPsec protects.
Local ID Type	Select from "Default", "ID", "FQDN", and "User FQDN".
Remote Subnet	Enter the remote subnet IP address that IPsec protects.
Remote Subnet Mask	Enter the remote netmask that IPsec protects.
Remote ID type	Select from "Default", "ID", "FQDN", and "User FQDN".

Table 3-2-5-2 IPsec Parameters

IKE Parameter	<input checked="" type="checkbox"/>
IKE Version	IKEv1
Negotiation Mode	Main
Encryption Algorithm	DES
Authentication Algorithm	MD5
DH Group	MODP768-1
Local Authentication	PSK
XAUTH	<input checked="" type="checkbox"/>
Lifetime(s)	10800

XAUTH List

Username	Password	Operation
		+

PSK List

Selector	PSK	Operation
		+

Figure 3-2-5-3

SA Parameter	<input checked="" type="checkbox"/>
SA Algorithm	DES-MD5
PFS Group	NULL
Lifetime(s)	3600
DPD Time Interval(s)	30
DPD Timeout(s)	150
IPsec Advanced	<input checked="" type="checkbox"/>
Enable Compression	<input type="checkbox"/>
VPN Over IPsec Type	NONE
Expert Options	

Figure 3-2-5-4

IKE Parameter	
Item	Description
IKE Version	Select from "IKEv1" and "IKEv2".
Negotiation Mode	Select from "Main" and "Aggressive".
Encryption Algorithm	Select from "DES", "3DES", "AES128", "AES192" and "AES256".
Authentication Algorithm	Select from "MD5" and "SHA1"
DH Group	Select from "MODP768_1", "MODP1024_2" and "MODP1536_5".
Local Authentication	Select from "PSK" and "CA".

XAUTH	Enter XAUTH username and password after XAUTH is enabled.
Lifetime (s)	Set the lifetime in IKE negotiation. Range: 60-86400.
XAUTH List	
Username	Enter the username used for the xauth authentication.
Password	Enter the password used for the xauth authentication.
PSK List	
Selector	Enter the corresponding identification number for PSK authentication.
PSK	Enter the pre-shared key.
SA Parameter	
SA Algorithm	Select from "DES_MD5", "DES_SHA1", "3DES_MD5", "3DES_SHA1", "AES128_MD5", "AES128_SHA1", "AES192_MD5", "AES192_SHA1", "AES256_MD5" and "AES256_SHA1".
PFS Group	Select from "NULL", "MODP768_1", "MODP1024_2" and "MODP1536_5".
Lifetime (s)	Set the lifetime of IPsec SA. Range: 60-86400.
DPD Interval Time(s)	Set DPD interval time to detect if the remote side fails.
DPD Timeout(s)	Set DPD timeout. Range: 10-3600.
IPsec Advanced	
Enable Compression	The head of IP packet will be compressed after it's enabled.
VPN Over IPsec Type	Select from "NONE", "GRE" and "L2TP" to enable VPN over IPsec function.
Expert Options	User can enter some other initialization strings in this field and separate the strings with ",". For example, if more local or remote subnet need to be added, users can add contents here.

Table 3-2-5-3 IPsec Server Parameters

3.2.5.3 IPsec

Figure 3-2-5-5

IPsec	
Item	Description
Enable	Enable IPsec tunnel. A maximum of 3 tunnels is allowed.
IPsec Gateway Address	Enter the IP address or domain name of remote IPsec server.
IPsec Mode	Select from "Tunnel" and "Transport".
IPsec Protocol	Select from "ESP" and "AH".
Local Subnet	Enter the local subnet IP address that IPsec protects.
Local Subnet Netmask	Enter the local netmask that IPsec protects.
Local ID Type	Select from "Default", "ID", "FQDN", and "User FQDN".
Remote Subnet	Enter the remote subnet IP address that IPsec protects.
Remote Subnet Mask	Enter the remote netmask that IPsec protects.
Remote ID type	Select from "Default", "ID", "FQDN", and "User FQDN".

Table 3-2-5-4 IPsec Parameters

IKE Parameter	<input checked="" type="checkbox"/>
IKE Version	IKEv1
Negotiation Mode	Main
Encryption Algorithm	AES128
Authentication Algorithm	SHA1
DH Group	MODP768-1
Local Authentication	PSK
Local Secrets
XAUTH	<input checked="" type="checkbox"/>
Username	
Password	
Lifetime(s)	28800
SA Parameter	<input type="checkbox"/>
IPsec Advanced	<input checked="" type="checkbox"/>
Enable Compression	<input checked="" type="checkbox"/>
VPN Over IPsec Type	NONE
Expert Options	

Figure 3-2-5-6

IKE Parameter	
Item	Description
IKE Version	Select from "IKEv1" and "IKEv2".
Negotiation Mode	Select from "Main" and "Aggressive".
Encryption Algorithm	Select from "DES", "3DES", "AES128", "AES192" and "AES256".
Authentication Algorithm	Select from "MD5" and "SHA1"
DH Group	Select from "MODP768_1", "MODP1024_2" and "MODP1536_5".
Local Authentication	Select from "PSK" and "CA".
Local Secrets	Enter the pre-shared key.
XAUTH	Enter XAUTH username and password after XAUTH is enabled.
Lifetime (s)	Set the lifetime in IKE negotiation. Range: 60-86400.
SA Parameter	
SA Algorithm	Select from "DES_MD5", "DES_SHA1", "3DES_MD5", "3DES_SHA1", "AES128_MD5", "AES128_SHA1", "AES192_MD5", "AES192_SHA1", "AES256_MD5" and "AES256_SHA1".

PFS Group	Select from "NULL", "MODP768_1", "MODP1024_2" and "MODP1536_5".
Lifetime (s)	Set the lifetime of IPsec SA. Range: 60-86400.
DPD Interval Time(s)	Set DPD interval time to detect if the remote side fails.
DPD Timeout(s)	Set DPD timeout. Range: 10-3600.
IPsec Advanced	
Enable Compression	The head of IP packet will be compressed after it's enabled.
VPN Over IPsec Type	Select from "NONE", "GRE" and "L2TP" to enable VPN over IPsec function.
Expert Option	User can enter some other initialization strings in this field and separate the strings with ",". For example, if more local or remote subnet need to be added, users can add contents here.

Table 3-2-5-5 IPsec Parameters

3.2.5.4 GRE

Generic Routing Encapsulation (GRE) is a protocol that encapsulates packets in order to route other protocols over IP networks. It's a tunneling technology that provides a channel through which encapsulated data message could be transmitted and encapsulation and decapsulation could be realized at both ends.

In the following circumstances the GRE tunnel transmission can be applied:

- GRE tunnel could transmit multicast data packets as if it were a true network interface. Single use of IPsec cannot achieve the encryption of multicast.
- A certain protocol adopted cannot be routed.
- A network of different IP addresses shall be required to connect other two similar networks.

The screenshot displays the 'GRE Settings' configuration page. At the top, there are navigation tabs: DMVPN, IPsec Server, IPsec, GRE (selected), L2TP, PPTP, and OpenVPN Client. Below the tabs, the 'GRE Settings' section is visible, with a sub-section for 'GRE_1'. The configuration fields are as follows:

- Enable:
- Remote IP Address:
- Local IP Address:
- Local Virtual IP Address:
- Netmask:
- Peer Virtual IP Address:
- Global Traffic Forwarding:
- Remote Subnet:
- Remote Netmask:
- MTU:
- Key:
- Enable NAT:

Figure 3-2-5-7

GRE	
Item	Description
Enable	Check to enable GRE function.
Remote IP Address	Enter the real remote IP address of GRE tunnel.
Local IP Address	Set the local IP address.
Local Virtual IP Address	Set the local tunnel IP address of GRE tunnel.
Netmask	Set the local netmask.
Peer Virtual IP Address	Enter remote tunnel IP address of GRE tunnel.
Global Traffic Forwarding	All the data traffic will be sent out via GRE tunnel when this function is enabled.
Remote Subnet	Enter the remote subnet IP address of GRE tunnel.
Remote Netmask	Enter the remote netmask of GRE tunnel.
MTU	Enter the maximum transmission unit. Range: 64-1500.
Key	Set GRE tunnel key.
Enable NAT	Enable NAT traversal function.

Table 3-2-5-6 GRE Parameters

3.2.5.5 L2TP

Layer Two Tunneling Protocol (L2TP) is an extension of the Point-to-Point Tunneling Protocol (PPTP) used by an Internet service provider (ISP) to enable the operation of a virtual private network (VPN) over the Internet.

The screenshot displays the 'L2TP Settings' configuration page. At the top, there are navigation tabs for DMVPN, IPsec Server, IPsec, GRE, L2TP (selected), PPTP, and OpenVPN Client. Below the tabs, the 'L2TP Settings' section is expanded to show 'L2TP_1' configuration. The settings include:

- Enable:** A checked checkbox.
- Remote IP Address:** A text input field containing '58.63.128.250'.
- Username:** A text input field containing 'user2'.
- Password:** A password input field with masked characters '*****'.
- Authentication:** A dropdown menu set to 'CHAP'.
- Global Traffic Forwarding:** A checked checkbox.
- Key:** An empty text input field.
- Advanced Settings:** A button with a right-pointing arrow.

Figure 3-2-5-8

L2TP	
Item	Description
Enable	Check to enable L2TP function.
Remote IP Address	Enter the public IP address or domain name of L2TP server.

Username	Enter the username that L2TP server provides.
Password	Enter the password that L2TP server provides.
Authentication	Select from "Auto", "PAP", "CHAP", "MS-CHAPv1" and "MS-CHAPv2".
Global Traffic Forwarding	All of the data traffic will be sent out via L2TP tunnel after this function is enabled.
Remote Subnet	Enter the remote IP address that L2TP protects.
Remote Subnet Mask	Enter the remote netmask that L2TP protects.
Key	Enter the password of L2TP tunnel.

Table 3-2-5-7 L2TP Parameters

Advanced Settings	<input checked="" type="checkbox"/>
Local IP Address	<input type="text"/>
Peer IP Address	<input type="text"/>
Enable NAT	<input checked="" type="checkbox"/>
Enable MPPE	<input checked="" type="checkbox"/>
Address/Control Compression	<input type="checkbox"/>
Protocol Field Compression	<input type="checkbox"/>
Asyncmap Value	<input type="text" value="ffffff"/>
MRU	<input type="text" value="1500"/>
MTU	<input type="text" value="1500"/>
Link Detection Interval(s)	<input type="text" value="60"/>
Max Retries	<input type="text" value="0"/>
Expert Options	<input type="text"/>

Figure 3-2-5-9

Advanced Settings	
Item	Description
Local IP Address	Set tunnel IP address of L2TP client. Client will obtain tunnel IP address automatically from the server when it's null.
Peer IP Address	Enter tunnel IP address of L2TP server.
Enable NAT	Enable NAT traversal function.
Enable MPPE	Enable MPPE encryption.
Address/Control Compression	For PPP initialization. User can keep the default option.
Protocol Field Compression	For PPP initialization. User can keep the default option.

Asynmap Value	One of the PPP protocol initialization strings. User can keep the default value. Range: 0-ffffff.
MRU	Set the maximum receive unit. Range: 64-1500.
MTU	Set the maximum transmission unit. Range: 64-1500
Link Detection Interval (s)	Set the link detection interval time to ensure tunnel connection. Range: 0-600.
Max Retries	Set the maximum times of retry to detect the L2TP connection failure. Range: 0-10.
Expert Options	User can enter some other PPP initialization strings in this field and separate the strings with blank space.

Table 3-2-5-8 L2TP Parameters

3.2.5.6 PPTP

Point-to-Point Tunneling Protocol (PPTP) is a protocol that allows corporations to extend their own corporate network through private "tunnels" over the public Internet. Effectively, a corporation uses a wide-area network as a single large local area network.

Figure 3-2-5-10

PPTP	
Item	Description
Enable	Enable PPTP client. A maximum of 3 tunnels is allowed.
Remote IP Address	Enter the public IP address or domain name of PPTP server.
Username	Enter the username that PPTP server provides.
Password	Enter the password that PPTP server provides.
Authentication	Select from "Auto", "PAP", "CHAP", "MS-CHAPv1", and "MS-CHAPv2".
Global Traffic	All of the data traffic will be sent out via PPTP tunnel once

Forwarding	enable this function.
Remote Subnet	Set the peer subnet of PPTP.
Remote Subnet Mask	Set the netmask of peer PPTP server.

Table 3-2-5-9 PPTP Parameters

Advanced Settings	<input checked="" type="checkbox"/>
Local IP Address	<input type="text"/>
Peer IP Address	<input type="text"/>
Enable NAT	<input checked="" type="checkbox"/>
Enable MPPE	<input checked="" type="checkbox"/>
Address/Control Compression	<input type="checkbox"/>
Protocol Field Compression	<input type="checkbox"/>
Asyncmap Value	<input type="text" value="ffffff"/>
MRU	<input type="text" value="1500"/>
MTU	<input type="text" value="1500"/>
Link Detection Interval(s)	<input type="text" value="60"/>
Max Retries	<input type="text" value="0"/>
Expert Options	<input type="text"/>

Figure 3-2-5-11

PPTP Advanced Settings	
Item	Description
Local IP Address	Set IP address of PPTP client.
Peer IP Address	Enter tunnel IP address of PPTP server.
Enable NAT	Enable the NAT function of PPTP.
Enable MPPE	Enable MPPE encryption.
Address/Control Compression	For PPP initialization. User can keep the default option.
Protocol Field Compression	For PPP initialization. User can keep the default option.
Asyncmap Value	One of the PPP protocol initialization strings. User can keep the default value. Range: 0-ffffff.
MRU	Enter the maximum receive unit. Range: 0-1500.
MTU	Enter the maximum transmission unit. Range: 0-1500.
Link Detection Interval (s)	Set the link detection interval time to ensure tunnel connection. Range: 0-600.
Max Retries	Set the maximum times of retrying to detect the PPTP connection failure. Range: 0-10.
Expert Options	User can enter some other PPP initialization strings in this

field and separate the strings with blank space.

Table 3-2-5-10 PPTP Parameters

Related Configuration Example

[PPTP Application Example](#)

3.2.5.7 OpenVPN Client

OpenVPN is an open source virtual private network (VPN) product that offers a simplified security framework, modular network design, and cross-platform portability.

Advantages of OpenVPN include:

- Security provisions that function against both active and passive attacks.
- Compatibility with all major operating systems.
- High speed (1.4 megabytes per second typically).
- Ability to configure multiple servers to handle numerous connections simultaneously.
- All encryption and authentication features of the OpenSSL library.
- Advanced bandwidth management.
- A variety of tunneling options.
- Compatibility with smart cards that support the Windows Crypt application program interface (API).

The screenshot displays the 'OpenVPN Client Settings' configuration page. The 'OpenVPN Client' tab is selected. The configuration is for a client named 'OpenVPN_1'. The settings are as follows:

- Enable:
- Protocol: UDP
- Remote IP Address: (empty)
- Port: 1194
- Interface: tun
- Authentication: None
- Local Tunnel IP: (empty)
- Remote Tunnel IP: (empty)
- Enable NAT:
- Compression: LZO
- Link Detection Interval(s): 60
- Link Detection Timeout(s): 300
- Cipher: None
- MTU: 1500
- Max Frame Size: 1500
- Verbose Level: ERRDR
- Expert Options: (empty)

Below the settings is a 'Local Route' table with the following structure:

Subnet	Subnet Mask	Operation
+		

Figure 3-2-5-12

OpenVPN Client	
Item	Description
Enable	Enable OpenVPN client. A maximum of 3 tunnels is allowed.
Protocol	Select from "UDP" and "TCP".
Remote IP Address	Enter remote OpenVPN server's IP address or domain name.
Port	Enter the listening port number of remote OpenVPN server. Range: 1-65535.
Interface	Select from "tun" and "tap".
Authentication	Select from "None", "Pre-shared", "Username/Password", "X.509 cert", and "X.509 cert+user".
Local Tunnel IP	Set local tunnel address.
Remote Tunnel IP	Enter remote tunnel address.
Global Traffic Forwarding	All the data traffic will be sent out via OpenVPN tunnel when this function is enabled.
Enable TLS Authentication	Check to enable TLS authentication.
Username	Enter username provided by OpenVPN server.
Password	Enter password provided by OpenVPN server.
Enable NAT	Enable NAT traversal function.
Compression	Select LZO to compress data.
Link Detection Interval (s)	Set link detection interval time to ensure tunnel connection. Range: 10-1800.
Link Detection Timeout (s)	Set link detection timeout. OpenVPN will be reestablished after timeout. Range: 60-3600.
Cipher	Select from "NONE", "BF-CBC", "DE-CBC", "DES-EDE3-CBC", "AES-128-CBC", "AES-192-CBC" and "AES-256-CBC".
MTU	Enter the maximum transmission unit. Range: 128-1500.
Max Frame Size	Set the maximum frame size. Range: 128-1500.
Verbose Level	Select from "ERROR", "WARNING", "NOTICE" and "DEBUG".
Expert Options	User can enter some other PPP initialization strings in this field and separate the strings with blank space.
Local Route	
Subnet	Set the local route's IP address.
Subnet Mask	Set the local route's netmask.

Table 3-2-5-11 OpenVPN Client Parameters

3.2.5.8 OpenVPN Server

The UR32L supports OpenVPN server to create secure point-to-point or site-to-site connections in routed or bridged configurations and remote access facilities.

Figure 3-2-5-13

Figure 3-2-5-14

OpenVPN Server	
Item	Description
Enable	Enable/disable OpenVPN server.
Protocol	Select from TCP and UDP.
Port	Fill in listening port number. Range: 1-65535.
Listening IP	Enter WAN IP address or LAN IP address. Leaving it blank refers to all active WAN IP and LAN IP address.
Interface	Select from " tun " and " tap ".
Authentication	Select from " None ", " Pre-shared ", " Username/Password ", " X.509 cert " and " X. 509 cert +user ".
Local Virtual IP	The local tunnel address of OpenVPN's tunnel.
Remote Virtual IP	The remote tunnel address of OpenVPN's tunnel.

Client Subnet	Local subnet IP address of OpenVPN client.
Client Netmask	Local netmask of OpenVPN client.
Renegotiation Interval(s)	Set interval for renegotiation. Range: 0-86400.
Max Clients	Maximum OpenVPN client number. Range: 1-128.
Enable CRL	Enable CRL
Enable Client to Client	Allow access between different OpenVPN clients.
Enable Dup Client	Allow multiple users to use the same certification.
Enable NAT	Check to enable the NAT traversal function.
Compression	Select "LZO" to compress data.
Link Detection Interval	Set link detection interval time to ensure tunnel connection. Range: 10-1800.
Cipher	Select from "NONE", "BF-CBC", "DES-CBC", "DES-EDE3-CBC", "AES-128-CBC", "AES-192-CBC" and "AES-256-CBC".
MTU	Enter the maximum transmission unit. Range: 64-1500.
Max Frame Size	Set the maximum frame size. Range: 64-1500.
Verbose Level	Select from "ERROR", "WARNING", "NOTICE" and "DEBUG".
Expert Options	User can enter some other PPP initialization strings in this field and separate the strings with blank space.
Local Route	
Subnet	The real local IP address of OpenVPN client.
Netmask	The real local netmask of OpenVPN client.
Account	
Username & Password	Set username and password for OpenVPN client.

Table 3-2-5-12 OpenVPN Server Parameters

3.2.5.9 Certifications

User can import/export certificate and key files for OpenVPN and IPsec on this page.

Field	Value	Buttons
CA	<input type="text"/>	Browse, Import, Export, Delete
Public Key	<input type="text"/>	Browse, Import, Export, Delete
Private Key	<input type="text"/>	Browse, Import, Export, Delete
TA	<input type="text"/>	Browse, Import, Export, Delete
Preshared Key	<input type="text"/>	Browse, Import, Export, Delete
FKCS12	<input type="text"/>	Browse, Import, Export, Delete

Figure 3-2-5-15

OpenVPN Client	
Item	Description
CA	Import/Export CA certificate file.
Public Key	Import/Export public key file.
Private Key	Import/Export private key file.
TA	Import/Export TA key file.
Preshared Key	Import/Export static key file.
PKCS12	Import/Export PKCS12 certificate file.

Table 3-2-5-13 OpenVPN Client Certification Parameters

OpenVPN Server

— OpenVPN Server

CA	<input type="text"/>	Browse	Import	Export	Delete
Public Key	<input type="text"/>	Browse	Import	Export	Delete
Private Key	<input type="text"/>	Browse	Import	Export	Delete
DH	<input type="text"/>	Browse	Import	Export	Delete
TA	<input type="text"/>	Browse	Import	Export	Delete
CRL	<input type="text"/>	Browse	Import	Export	Delete
Preshared Key	<input type="text"/>	Browse	Import	Export	Delete

Figure 3-2-5-16

OpenVPN Server	
Item	Description
CA	Import/Export CA certificate file.
Public Key	Import/Export public key file.
Private Key	Import/Export private key file.
DH	Import/Export DH key file.
TA	Import/Export TA key file.
CRL	Import/Export CRL.
Preshared Key	Import/Export static key file.

Table 3-2-5-14 OpenVPN Server Parameters

IPsec

— IPsec_1

CA	<input type="text"/>	Browse	Import	Export	Delete
Client Key	<input type="text"/>	Browse	Import	Export	Delete
Server Key	<input type="text"/>	Browse	Import	Export	Delete
Private Key	<input type="text"/>	Browse	Import	Export	Delete
CRL	<input type="text"/>	Browse	Import	Export	Delete

Figure 3-2-5-17

IPsec	
Item	Description
CA	Import/Export CA certificate.
Client Key	Import/Export client key.
Server Key	Import/Export server key.
Private Key	Import/Export private key.
CRL	Import/Export certificate recovery list.

Table 3-2-5-15 IPsec Parameters

IPsec Server

— IPsec Server

CA	<input type="text"/>	Browse	Import	Export	Delete
Local Certificate	<input type="text"/>	Browse	Import	Export	Delete
Private Key	<input type="text"/>	Browse	Import	Export	Delete
CRL	<input type="text"/>	Browse	Import	Export	Delete

Figure 3-2-5-18

IPsec Server	
Item	Description
CA	Import/Export CA certificate.
Local Certificate	Import/Export Local Certificate file.
Private Key	Import/Export private key.
CRL	Import/Export certificate recovery list.

Table 3-2-5-16 IPsec Server Parameters

3.2.6 IP Passthrough

IP Passthrough mode shares or "passes" the Internet providers assigned IP address to a single LAN client device connected to the router.

Figure 3-2-6-1

IP Passthrough	
Item	Description
Enable	Enable or disable IP Passthrough.
Passthrough Mode	Select passthrough mode from "DHCPs-Fixed" and "DHCPs-Dynamic".
MAC	Set MAC address.

Table 3-2-6-1 IP Passthrough Parameters

3.2.7 Routing

3.2.7.1 Static Routing

A static routing is a manually configured routing entry. Information about the routing is manually entered rather than obtained from dynamic routing traffic. After setting static routing, the package for the specified destination will be forwarded to the path designated by user.

Figure 3-2-7-1

Static Routing	
Item	Description
Destination	Enter the destination IP address.
Netmask/Prefix Length	Enter the subnet mask or prefix length of destination address.
Interface	The interface through which the data can reach the destination address.
Gateway	IP address of the next router that will be passed by before the input data reaches the destination address.
Distance	Priority, smaller value refers to higher priority. Range: 1-255.

Table 3-2-7-1 Static Routing Parameters

3.2.7.2 RIP

RIP is mainly designed for small networks. RIP uses Hop Count to measure the distance to the destination address, which is called Metric. In RIP, the hop count from the router to its directly connected network is 0 and the hop count of network to be reached through a router is 1 and so on. In order to limit the convergence time, the specified metric of RIP is an integer in the range of 0 - 15 and the hop count larger than or equal to 16 is defined as infinity, which means that the destination network or host is unreachable. Because of this limitation, the RIP is not suitable for large-scale networks. To improve performance and prevent routing loops, RIP supports split horizon function. RIP also introduces routing obtained by other routing protocols.

Each router that runs RIP manages a routing database, which contains routing entries to reach all reachable destinations.

The screenshot displays the configuration interface for RIP. It includes the following settings:

- Static Routing** (selected tab): RIP, OSPF, Routing Filtering
- RIP Settings**
 - Enable:
 - Update Timer: s
 - Timeout Timer: s
 - Garbage Collection Timer: s
 - Version:
 - Show Advanced Options:
 - Default Information Originate:
 - Default Metric:
 - Redistribute Connected:
 - Redistribute Static:
 - Redistribute OSPF:

Figure 3-2-7-2

RIP	
Item	Description
Enable	Enable or disable RIP.
Update Timer	It defines the interval to send routing updates. Range: 5-2147483647, in seconds.
Timeout Timer	It defines the routing aging time. If no update package on a routing is received within the aging time, the routing's Routing Cost in the routing table will be set to 16. Range: 5-2147483647, in seconds.
Garbage Collection Timer	It defines the period from the routing cost of a routing becomes 16 to it is deleted from the routing table. In the time of Garbage-Collection, RIP uses 16 as the routing cost for sending routing updates. If Garbage Collection times out and the routing still has not been updated, the routing will be completely removed from the routing table. Range: 5-2147483647, in seconds.
Version	RIP version. The options are v1 and v2.
Advanced Settings	
Default Information Originate	Default information will be released when this function is enabled.
Default Metric	The default cost for the router to reach destination. Range: 0-16
Redistribute Connected	Check to enable.
Metric	Set metric after "Redistribute Connected" is enabled. Range: 0-16.
Redistribute Static	Check to enable.
Metric	Set metric after "Redistribute Static" is enabled. Range: 0-16.
Redistribute OSPF	Check to enable.
Metric	Set metric after "Redistribute OSPF" is enabled. Range: 0-16.

Table 3-2-7-2 RIP Parameters

Distance/Metric Management							
Distance	IP Address	Netmask	ACL Name	Operation			
Metric	Policy In/Out	Interface	ACL Name	Operation			
Filter Policy							
Policy Type	Policy Name	Policy In/Out	Interface	Operation			
Passive Interface							
		Passive Interface		Operation			
Interface							
Interface	Send Version	Receive Version	Split-Horizon	Authentication Mode	Authentication String	Authentication Key-chain	Operation
Neighbor							
			IP Address				Operation
Network							
		IP Address		Netmask			Operation

Figure 3-2-7-3

Item	Description
Distance/Metric Management	
Distance	Set the administrative distance that a RIP route learns. Range: 1-255.
IP Address	Set the IP address of RIP route.
Netmask	Set the netmask of RIP route.
ACL Name	Set ACL name of RIP route.
Metric	The metric of received route or sent route from the interface. Range: 0-16.
Policy in/out	Select from "in" and "out".

Interface	Select interface of the route.
ACL Name	Access control list name of the route strategy.
Filter Policy	
Policy Type	Select from "access-list" and "prefix-list".
Policy Name	User-defined prefix-list name.
Policy in/out	Select from "in" and "out".
Interface	Select interface from "cellular0", "LAN1/WAN" and "Bridge0".
Passive Interface	
Passive Interface	Select interface from "cellular0" and "LAN1/WAN", "Bridge0".
Interface	
Interface	Select interface from "cellular0", "LAN1/WAN" and "Bridge0".
Send Version	Select from "default", "v1" and "v2".
Receive Version	Select from "default", "v1" and "v2".
Split-Horizon	Select from "enable" and "disable".
Authentication Mode	Select from "text" and "md5".
Authentication String	The authentication key for package interaction in RIPv2.
Authentication Key-chain	The authentication key-chain for package interaction in RIPv2.
Neighbor	
IP Address	Set RIP neighbor's IP address manually.
Network	
IP Address	The IP address of interface for RIP publishing.
Netmask	The netmask of interface for RIP publishing.

Table 3-2-7-3

3.2.7.3 OSPF

OSPF, short for Open Shortest Path First, is a link status based on interior gateway protocol developed by IETF.

If a router wants to run the OSPF protocol, there should be a Router ID that can be manually configured. If no Router ID configured, the system will automatically select an IP address of interface as the Router ID. The selection order is as follows:

- If a Loopback interface address is configured, then the last configured IP address of Loopback interface will be used as the Router ID;
- If no Loopback interface address is configured, the system will choose the interface with the biggest IP address as the Router ID.

Five types of packets of OSPF:

- Hello packet

- **DD packet** (Database Description Packet)
- **LSR packet** (Link-State Request Packet)
- **LSU packet** (Link-State Update Packet)
- **LSAck packet** (Link-Sate Acknowledgment Packet)

Neighbor and Neighboring

After OSPF router starts up, it will send out Hello Packets through the OSPF interface. Upon receipt of Hello packet, OSPF router will check the parameters defined in the packet. If it's consistent, a neighbor relationship will be formed. Not all matched sides in neighbor relationship can form the adjacency relationship. It is determined by the network type. Only when both sides successfully exchange DD packets and LSDB synchronization is achieved, the adjacency in the true sense can be formed. LSA describes the network topology around a router, LSDB describes entire network topology.

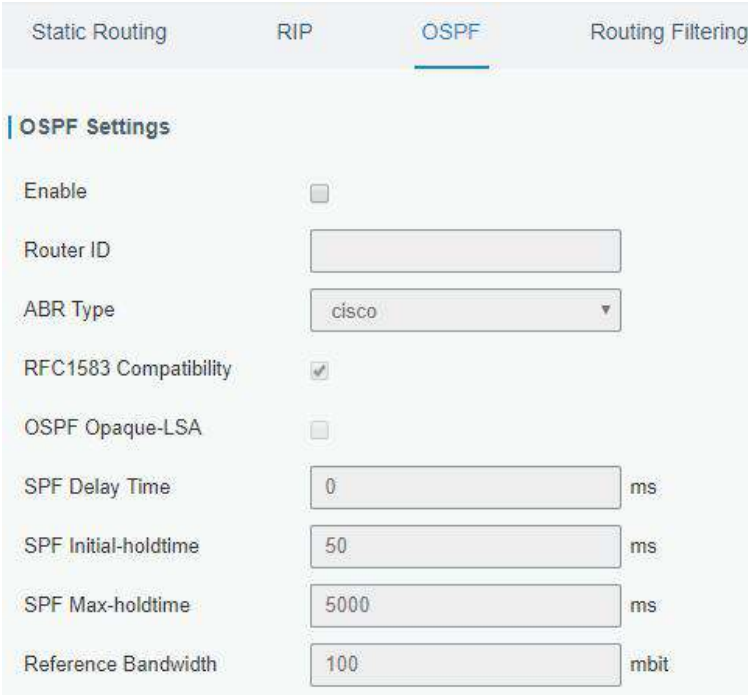

Figure 3-2-7-4

OSPF	
Item	Description
Enable	Enable or disable OSPF.
Router ID	Router ID (IP address) of the originating LSA.
ABR Type	Select from cisco, ibm, standard and shortcut.
RFC1583 Compatibility	Enable/Disable.
OSPF Opaque-LSA	Enable/Disable LSA: a basic communication means of the OSPF routing protocol for the Internet Protocol (IP).
SPF Delay Time	Set the delay time for OSPF SPF calculations. Range: 0-6000000, in milliseconds.

SPF Initial-holdtime	Set the initialization time of OSPF SPF. Range: 0-6000000, in milliseconds.
SPF Max-holdtime	Set the maximum time of OSPF SPF. Range: 0-6000000, in milliseconds.
Reference Bandwidth	Range: 1-4294967, in Mbit.

Table 3-2-7-4 OSPF Parameters

Interface

Interface	Hello Interval(s)	Dead Interval(s)	Retransmit Interval(s)	Transmit Delay(s)	Operation
Bridge0	10	40	5	1	<input type="button" value="X"/> <input type="button" value="+"/>

Interface Advanced Options

Interface	Network	Cost	Priority	Authentication	Key ID	Key	Operation
Bridge	broad	10	1				<input type="button" value="X"/> <input type="button" value="+"/>

Figure 3-2-7-5

Item	Description
Interface	
Interface	Select interface from "cellular0", "WAN" and "Bridge0".
Hello Interval (s)	Send interval of Hello packet. If the Hello time between two adjacent routers is different, the neighbour relationship cannot be established. Range: 1-65535.
Dead Interval (s)	Dead Time. If no Hello packet is received from the neighbours within the dead time, then the neighbour is considered failed. If dead times of two adjacent routers are different, the neighbour relationship cannot be established.
Retransmit Interval (s)	When the router notifies an LSA to its neighbour, it is required to make acknowledgement. If no acknowledgement packet is received within the retransmission interval, this LSA will be retransmitted to the neighbour. Range: 3-65535.
Transmit Delay (s)	It will take time to transmit OSPF packets on the link. So a certain delay time should be increased before transmission the aging time of LSA. This configuration needs to be further considered on the low-speed link. Range: 1-65535.
Interface Advanced Options	
Interface	Select interface.
Network	Select OSPF network type.
Cost	Set the cost of running OSPF on an interface. Range: 1-65535.
Priority	Set the OSPF priority of interface. Range: 0-255.
Authentication	Set the authentication mode that will be used by the OSPF area.

	Simple: a simple authentication password should be configured and confirmed again. MD5: MD5 key & password should be configured and confirmed again.
Key ID	It only takes effect when MD5 is selected. Range 1-255.
Key	The authentication key for OSPF packet interaction.

Table 3-2-7-5 OSPF Parameters

The screenshot shows a configuration interface with four main sections:

- Passive Interface:** A table with one column 'Passive Interface' and one column 'Operation'. A blue '+' button is at the bottom right.
- Network:** A table with columns 'IP Address', 'Netmask', 'Area ID', and 'Operation'. A blue '+' button is at the bottom right.
- Neighbor:** A table with columns 'IP Address', 'Priority', 'Poll', and 'Operation'. A blue '+' button is at the bottom right.
- Area:** A table with columns 'Area ID', 'Area', 'No Summary', 'Authentication', and 'Operation'. A blue '+' button is at the bottom right.

Figure 3-2-7-6

Item	Description
Passive Interface	
Passive Interface	Select interface from "cellular0", "LAN1/WAN" and "Bridge0".
Network	
IP Address	The IP address of local network.
Netmask	The netmask of local network.
Area ID	The area ID of original LSA's router.
Area	
Area ID	Set the ID of the OSPF area (IP address).
Area	Select from "Stub" and "NSSA". The backbone area (area ID 0.0.0.0) cannot be set as "Stub" or "NSSA".
No Summary	Forbid route summarization.
Authentication	Select authentication from "simple" and "md5".

Table 3-2--7-6 OSPF Parameters

Area Advanced Options

Area Range

Area ID	IP Address	Netmask	No Advertise	Cost	Operation
					+

Area Filter

Area ID	Filter Type	ACL Name	Operation
			+

Area Virtual Link



Area ID	ABR Address	Authentication	Key ID	Key	Hello Interval	Dead Interval	Retransmit Interval	Transmit Delay	Operation
									+

Figure 3-2-7-7

Area Advanced Options	
Item	Description
Area Range	
Area ID	The area ID of the interface when it runs OSPF (IP address).
IP Address	Set the IP address.
Netmask	Set the netmask.
No Advertise	Forbid the route information to be advertised among different areas.
Cost	Range: 0-16777215
Area Filter	
Area ID	Select an Area ID for Area Filter.
Filter Type	Select from "import", "export", "filter-in", and "filter-out".
ACL Name	Enter an ACL name which is set on "Routing > Routing Filtering" webpage.
Area Virtual Link	
Area ID	Set the ID number of OSPF area.
ABR Address	ABR is the router connected to multiple outer areas.
Authentication	Select from "simple" and "md5".
Key ID	It only takes effect when MD5 is selected. Range 1-15.
Key	The authentication key for OSPF packet interaction.
Hello Interval	Set the interval time for sending Hello packets through the interface. Range: 1-65535.
Dead Interval	The dead interval time for sending Hello packets through the interface. Range: 1-65535.
Retransmit Interval	The retransmission interval time for re-sending LSA. Range: 1-65535.
Transmit Delay	The delay time for LSA transmission. Range: 1-65535.

Table 3-2-7-7 OSPF Parameters

Redistribution

Redistribution Type	Metric	Metric Type	Route Map	Operation
connected		1		
				

Redistribution Advanced Options

Always Redistribute Default Route

Redistribute Default Route Metric

Redistribute Default Route Metric Type

Distance Management

Area Type	Distance	Operation
		

Figure 3-2-7-8

Item	Description
Redistribution	
Redistribution Type	Select from "connected", "static" and "rip".
Metric	The metric of redistribution router. Range: 0-16777214.
Metric Type	Select Metric type from "1" and "2".
Route Map	Mainly used to manage route for redistribution.
Redistribution Advanced Options	
Always Redistribute Default Route	Send redistribution default route after starting up.
Redistribute Default Route Metric	Send redistribution default route metric. Range: 0-16777214.
Redistribute Default Route Metric Type	Select from "0", "1" and "2".
Distance Management	
Area Type	Select from "intra-area", "inter-area" and "external".
Distance	Set the OSPF routing distance for area learning. Range: 1-255.

Table 3-2-7-8 OSPF Parameters

3.2.7.4 Routing Filtering

Figure 3-2-7-9

Routing Filtering	
Item	Description
Access Control List	
Name	User-defined name, need to start with a letter. Only letters, digits and underline (_) are allowed.
Action	Select from "permit" and "deny".
Match Any	No need to set IP address and subnet mask.
IP Address	User-defined.
Netmask	User-defined.
IP Prefix-List	
Name	User-defined name, need to start with a letter. Only letters, digits and underline (_) are allowed.
Sequence Number	A prefix name list can be matched with multiple rules. One rule is matched with one sequence number. Range: 1-4294967295.
Action	Select from "permit" and "deny".
Match Any	No need to set IP address, subnet mask, FE Length, and LE Length.
IP Address	User-defined.
Netmask	User-defined.
FE Length	Specify the minimum number of mask bits that must be matched. Range: 0-32.
LE Length	Specify the maximum number of mask bits that must be matched. Range: 0-32.

Table 3-2-7-9 Routing Filtering Parameters

3.2.8 VRRP

The Virtual Router Redundancy Protocol (VRRP) is a computer networking protocol that provides automatic assignment of available Internet Protocol (IP) routers for participating hosts. This increases the availability and reliability of routing paths via automatic default gateway selections in

an IP sub-network.

Increasing the number of exit gateway is a common method for improving system reliability. VRRP adds a group of routers that undertake gateway function into a backup group so as to form a virtual router. The election mechanism of VRRP will decide which router undertakes the forwarding task, and the host in LAN is only required to configure the default gateway for the virtual router.

In VRRP, routers need to be aware of failures in the virtual master router. To achieve this, the virtual master router sends out multicast "alive" announcements to the virtual backup routers in the same VRRP group.

The VRRP router who has the highest number will become the virtual master router. The VRRP router number ranges from 1 to 255 and usually we use 255 for the highest priority and 100 for backup.

If the current virtual master router receives an announcement from a group member (Router ID) with a higher priority, then the latter will pre-empt and become the virtual master router.

VRRP has the following characteristics:

- The virtual router with an IP address is known as the Virtual IP address. For the host in LAN, it is only required to know the IP address of virtual router, and set it as the address of the next hop of the default route.
- The network Host communicates with the external network through this virtual router.
- A router will be selected from the set of routers based on its priority to undertake the gateway function. Other routers will be used as backup routers to perform the duties of gateway for the gateway router in the case of any malfunction, so as to guarantee uninterrupted communication between the host and external network.

When interface connected with the uplink is at the state of Down or Removed, the router actively lowers its priority so that priority of other routers in the backup group will be higher. Thus the router with the highest priority becomes the gateway for the transmission task.

VRRP	
VRRP Status	
Status	DISABLE
VRRP Settings	
Enable	<input type="checkbox"/>
Interface	Bridge0
Virtual Router ID	1
Virtual IP	
Priority	100
Advertisement Interval (s)	1
Preemption Mode	<input type="checkbox"/>
IPv4 Primary Server	8.8.8.8
IPv4 Secondary Server	114.114.114.114
Interval	300 s
Retry Interval	5 s
Timeout	3 s
Max Ping Retries	3
Save	

Figure 3-2-8-1

VRRP		
Item	Description	Default
Enable	Enable or disable VRRP.	Disable
Interface	Select the interface of Virtual Router.	None
Virtual Router ID	User-defined Virtual Router ID. Range: 1-255.	None
Virtual IP	Set the IP address of Virtual Router.	None
Priority	The VRRP priority range is 1-254 (a bigger number indicates a higher priority). The router with higher priority will be more likely to become the gateway router.	100
Advertisement Interval (s)	Heartbeat package transmission time interval between routers in the virtual ip group. Range: 1-255.	1
Preemption Mode	If the router works in the preemption mode, once it finds that its own priority is higher than that of the current gateway router, it will send VRRP notification package, resulting in re-election of gateway router and eventually replacing the original gateway router. Accordingly, the original gateway router will become a Backup router.	Disable
IPV4 Primary Server	The router will send ICMP packet to the IP address or host name to determine whether the Internet connection is still available or not.	8.8.8.8
IPV4 Secondary Server	The router will try to ping the secondary server name if primary server is not available.	114.114. 114.114
Interval	Time interval (in seconds) between two Pings.	300
Retry Interval	Set the ping retry interval. When ping failed, the router will ping again every retry interval.	5
Timeout	The maximum amount of time the router will wait for a response to a ping request. If it does not receive a response for the amount of time defined in this field, the ping request will be considered as failure.	3
Max Ping Retries	The retry times of the router sending ping request until determining that the connection has failed.	3

Table 3-2-8-1 VRRP Parameters

Related Configuration Example

[VRRP Application Example](#)

3.2.9 DDNS

Dynamic DNS (DDNS) is a method that automatically updates a name server in the Domain Name System, which allows user to alias a dynamic IP address to a static domain name.

DDNS serves as a client tool and needs to coordinate with DDNS server. Before starting configuration, user shall register on a website of proper domain name provider and apply for a domain name.

DDNS

| DDNS Status

Status 🔍

| DDNS Method List

Enable

Name

Service Type DynDNS ▾

Username

User ID

Password

Server

Server Path

Hostname

Append IP

Use HTTPS

Figure 3-2-9-1

DDNS	
Item	Description
Enable	Enable/disable DDNS.
Name	Give the DDNS a descriptive name.
Interface	Set interface bundled with the DDNS.
Service Type	Select the DDNS service provider.
Username	Enter the username for DDNS register.
User ID	Enter User ID of the custom DDNS server.
Password	Enter the password for DDNS register.
Server	Enter the name of DDNS server.
Server Path	By default the hostname is appended to the path.
Hostname	Enter the hostname for DDNS.
Append IP	Append your current IP to the DDNS server update path.

Use HTTPS	Enable HTTPS for some DDNS providers.
-----------	---------------------------------------

Table 3-2-9-1 DDNS Parameters

3.3 System

This section describes how to configure general settings, such as administration account, access service, system time, common user management, SNMP, AAA, event alarms, etc.

3.3.1 General Settings

3.3.1.1 General

General settings include system info and HTTPS certificates.

Figure 3-3-1-1

General		
Item	Description	Default
System		
Hostname	User-defined router name, needs to start with a letter.	ROUTER
Web Login Timeout (s)	You need to log in again if it times out. Range: 100-3600.	1800
Encrypting Cleartext Passwords	This function will encrypt all of cleartext passwords into ciphertext passwords.	Enable
HTTPS Certificates		
Certificate	Click "Browse" button, choose certificate file on the PC, and then click "Import" button to upload the file into router. Click "Export" button will export the file to the PC. Click "Delete" button will delete the file.	--
Key	Click "Browse" button, choose key file on the PC, and then	--

click "Import" button to upload the file into router. Click "Export" button will export file to the PC. Click "Delete" button will delete the file.

Table 3-3-1-1 General Setting Parameters

3.3.1.2 System Time

This section explains how to set the system time including time zone and time synchronization type.

Note: to ensure that the router runs with the correct time, it's recommended that you set the system time when configuring the router.

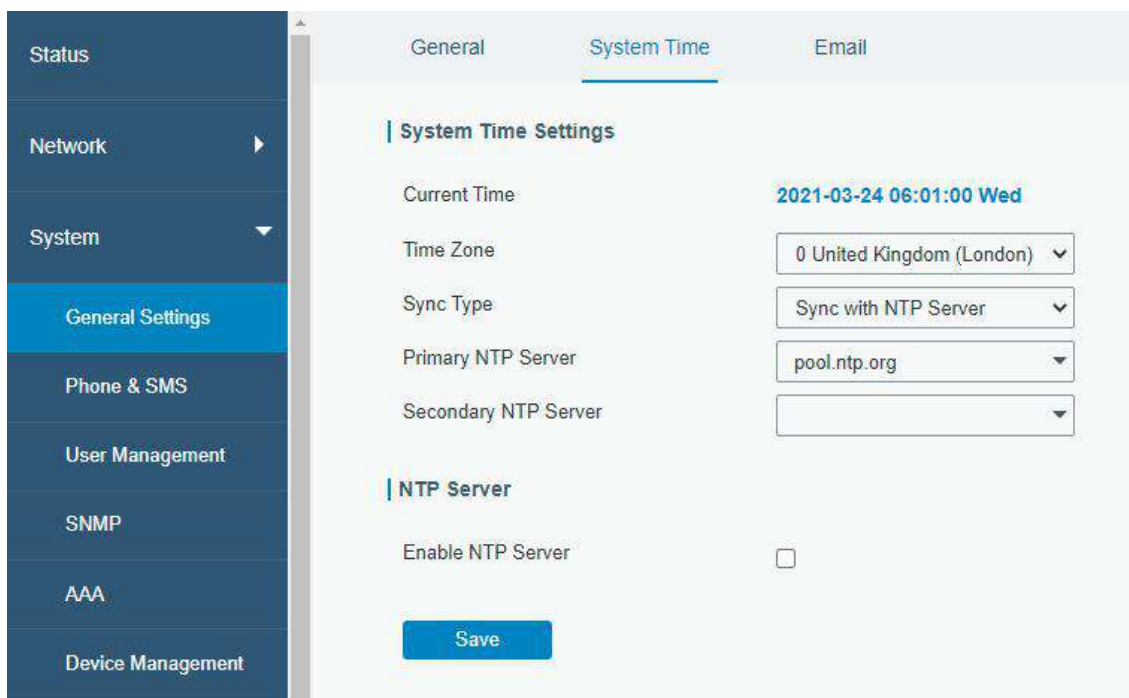

Figure 3-3-1-2

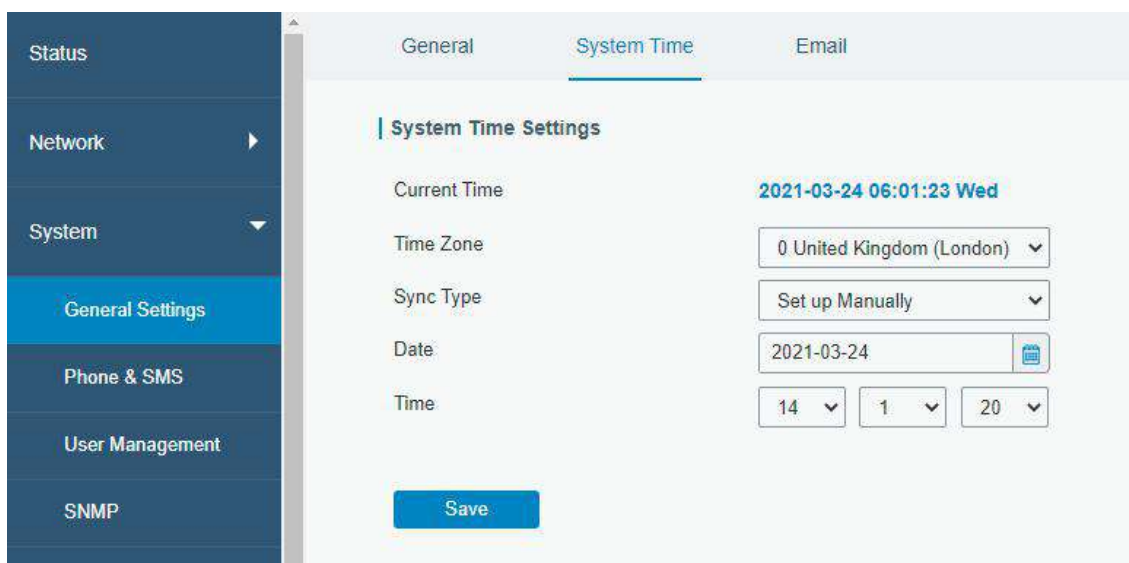

Figure 3-3-1-3

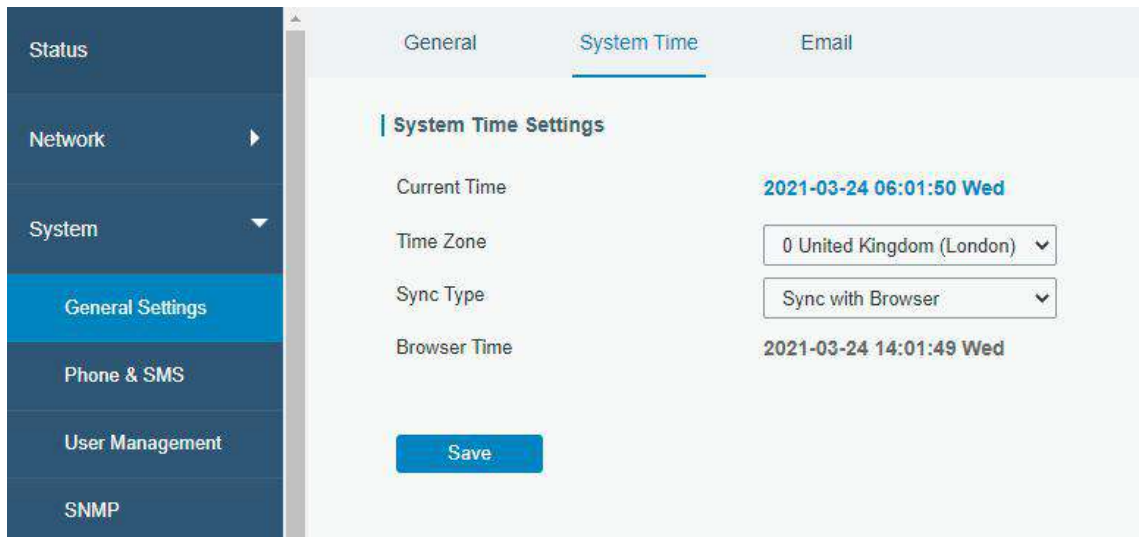

Figure 3-3-1-4

System Time	
Item	Description
Current Time	Show the current system time.
Time Zone	Click the drop down list to select the time zone you are in.
Sync Type	Click the drop down list to select the time synchronization type.
Sync with Browser	Synchronize time with browser.
Browser Time	Show the current time of browser.
Set up Manually	Manually configure the system time.
Primary NTP Server	Enter primary NTP Server's IP address or domain name.
Secondary NTP Server	Enter secondary NTP Server's IP address or domain name.
NTP Server	
Enable NTP Server	NTP client on the network can achieve time synchronization with router after "Enable NTP Server" option is checked.

Table 3-3-1-2 System Time Parameters

3.3.1.3 Email

SMTP, short for Simple Mail Transfer Protocol, is a TCP/IP protocol used in sending and receiving e-mail. This section describes how to configure email settings and add email groups for alarms and events.

Figure 3-3-1-5

SMTP Client Settings	
Item	Description
Enable	Enable or disable SMTP client function.
Email Address	Enter the sender's email account.
Password	Enter the sender's email password.
SMTP Server Address	Enter SMTP server's domain name.
Port	Enter SMTP server port. Range: 1-65535.
Encryption	Select from: None, TLS/SSL, STARTTLS. None: No encryption. The default port is 25. STARTTLS: STARTTLS is a way to take an existing insecure connection and upgrade it to a secure connection by using SSL/TLS. The default port is 587. TLS/SSL: SSL and TLS both provide a way to encrypt a communication channel between two computers (e.g. your computer and our server). TLS is the successor to SSL and the terms SSL and TLS are used interchangeably unless you're referring to a specific version of the protocol. The default port is 465.

Table 3-3-1-3 SMTP Setting

The screenshot displays two configuration sections in a web interface:

- Email List:** A table with three columns: 'Email Address', 'Description', and 'Operation'. The 'Email Address' and 'Description' columns contain text input fields. The 'Operation' column contains a blue 'X' icon for deletion and a blue '+' icon for adding new entries.
- Email Group List:** A form with three input fields: 'Group ID', 'Description', and 'List'. Below the 'List' field is a list box with a vertical scrollbar. To the right of the list box are four blue arrow buttons (right, right, left, left) for moving items between the list and a 'Selected' list box on the far right. At the bottom of this section are 'Save' and 'Cancel' buttons.

Figure 3-3-1-6

Item	Description
Email List	
Email Address	Enter the Email address.
Description	The description of the Email address.
Email Group List	
Group ID	Set number for email group. Range: 1-100.
Description	The description of the Email group.
List	Show the Email address list.
Selected	Show the selected Email address.

Table 3-3-1-4 Email Settings

Related Topics

[Events Setting](#)

[Events Application Example](#)

3.3.2 Phone&SMS

3.3.2.1 Phone

Phone settings involve in call/SMS trigger, SMS control and SMS alarm for events.

The screenshot shows a web interface for configuring phone settings. At the top, there are tabs for 'Phone' and 'SMS'. Below the 'Phone' tab, there are two main sections: 'Phone Number List' and 'Phone Group List'.

Phone Number List: This section contains a table with three columns: 'Number', 'Description', and 'Operation'. The 'Number' and 'Description' columns have input fields. The 'Operation' column has a delete icon (X) and an add icon (+).

Phone Group List: This section contains several input fields and lists. There are fields for 'Group ID' and 'Description'. Below these are two lists: 'List' and 'Selected'. Between the lists are four arrow buttons (right, right, left, left) for moving items between the lists. At the bottom of this section are 'Save' and 'Cancel' buttons.

Figure 3-3-2-1

Phone	
Item	Description
Phone Number List	
Number	Enter the telephone number. Digits, "+" and "-" are allowed.
Description	The description of the telephone number.
Phone Group List	
Group ID	Set number for phone group. Range: 1-100.
Description	The description of the phone group.
List	Show the phone list.
Selected	Show the selected phone number.

Table 3-3-2-1 Phone Settings

Related Topic

[Connect on Demand](#)

3.3.2.2 SMS

SMS settings involve in remote SMS control, sending SMS and SMS receiving and sending status.

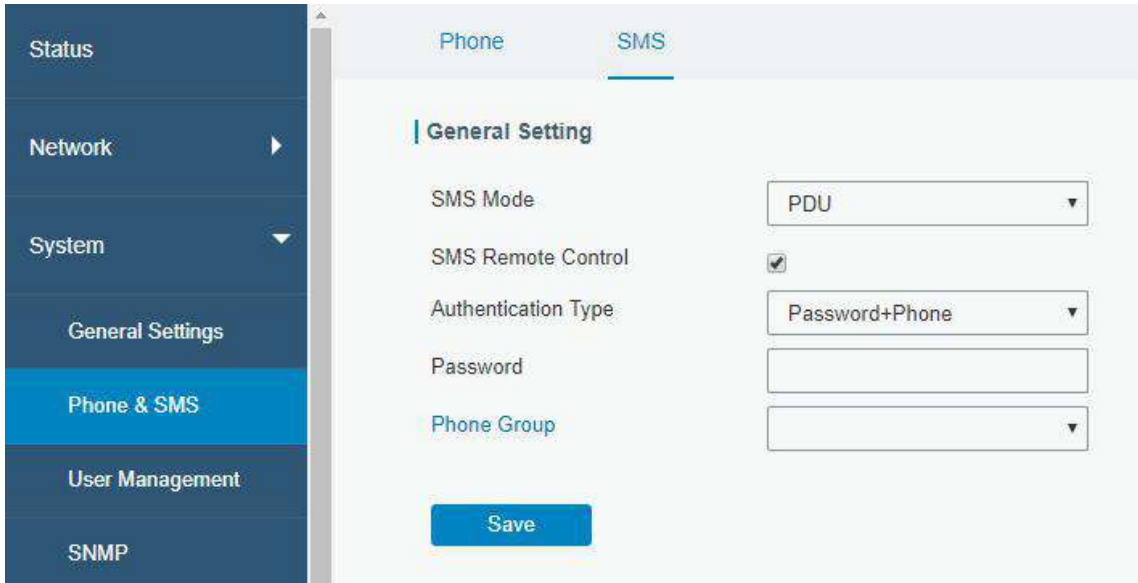

Figure 3-3-2-2

SMS Settings	
Item	Description
SMS Mode	Select SMS mode from "TEXT" and "PDU".
SMS Remote Control	Enable/disable SMS Remote Control.
Authentication Type	You can choose "phone number" or "password + phone number". Phone number: Use phone number for authentication. Password + phone number: Use both ""Password"" and ""Phone number"" for authentication.
Password	Set password for authentication.
Phone Group	Select the Phone group which used for remote control. User can click the Phone Group and set phone number.

Table 3-3-2-2 SMS Remote Control Parameters

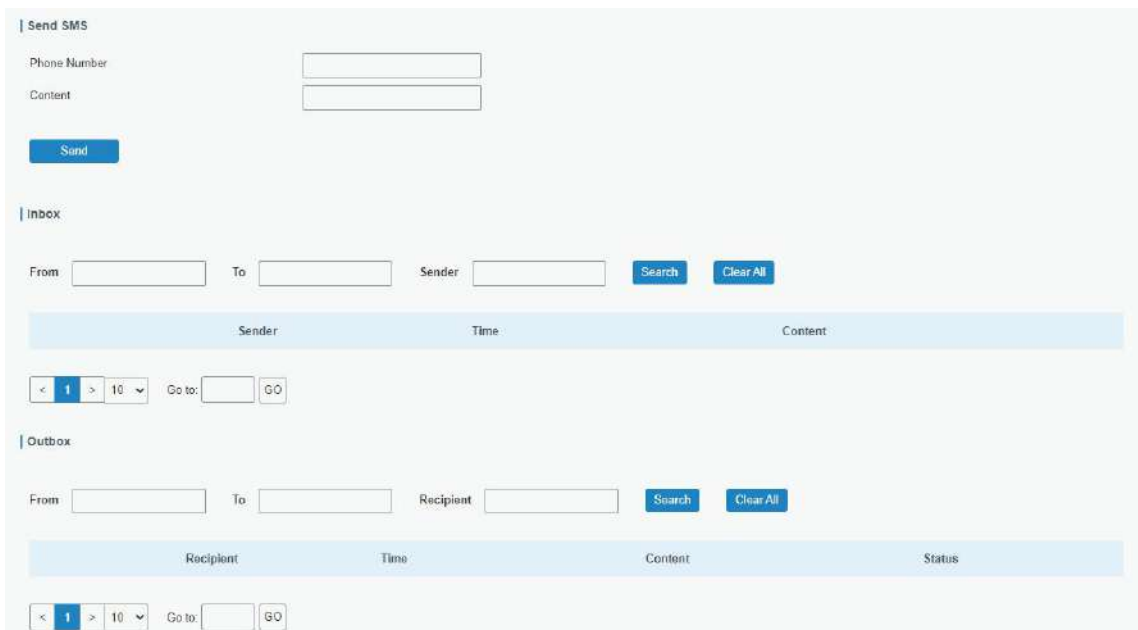

Figure 3-3-2-3

SMS	
Item	Description
Send SMS	
Phone Number	Enter the number to receive the SMS.
Content	SMS content.
Inbox/Outbox	
Sender	SMS sender from outside.
Recipient	SMS recipient which UR32L send to.
From	Select the start date.
To	Select the end date.
Search	Search for SMS record.
Clear All	Clear all SMS records in web GUI.

Table 3-3-2-3 SMS Settings

3.3.3 User Management

3.3.3.1 Account

Here you can change the login username and password of the administrator.

Note: it is strongly recommended that you modify them for the sake of security.

Figure 3-3-3-1

Account	
Item	Description
Username	Enter a new username. You can use characters such as a-z, 0-9, "_", "-", "\$". The first character can't be a digit.
Old Password	Enter the old password.
New Password	Enter a new password.
Confirm New Password	Enter the new password again.

Table 3-3-3-1 Account Settings

3.3.3.2 User Management

This section describes how to create common user accounts.

The common user permission includes Read-Only and Read-Write.

The screenshot shows a web interface for 'User Management'. At the top, there are tabs for 'Account' and 'User Management'. Below the tabs is a 'User List' section. The main area contains a form with four columns: 'Username', 'Password', 'Permission', and 'Operation'. The 'Username' and 'Password' fields are empty text boxes. The 'Permission' field is a dropdown menu currently showing 'Read-Only'. The 'Operation' column contains a blue button with a plus sign (+) and a blue button with an 'x' (delete).

Figure 3-3-3-2

User Management	
Item	Description
Username	Enter a new username. You can use characters such as a-z, 0-9, "_", "-", "\$". The first character can't be a digit.
Password	Set password.
Permission	Select user permission from "Read-Only" and "Read-Write". <ul style="list-style-type: none"> - Read-Only: users can only view the configuration of router in this level. - Read-Write: users can view and set the configuration of router in this level.

Table 3-3-3-2 User Management

3.3.4 SNMP

SNMP is widely used in network management for network monitoring. SNMP exposes management data with variables form in managed system. The system is organized in a management information base (MIB) which describes the system status and configuration. These variables can be remotely queried by managing applications.

Configuring SNMP in networking, NMS, and a management program of SNMP should be set up at the Manager.

Configuration steps are listed as below for achieving query from NMS:

1. Enable SNMP setting.
2. Download MIB file and load it into NMS.
3. Configure MIB View.
4. Configure VCAM.

Related Configuration Example

[SNMP Application Example](#)

3.3.4.1 SNMP

UR32L supports SNMPv1, SNMPv2c and SNMPv3 version. SNMPv1 and SNMPv2c employ community name authentication. SNMPv3 employs authentication encryption by username and password.

Figure 3-3-4-1

SNMP Settings	
Item	Description
Enable	Enable or disable SNMP function.
Port	Set SNMP listened port. Range: 1-65535. The default port is 161.
SNMP Version	Select SNMP version; support SNMP v1/v2c/v3.
Location Information	Fill in the location information.
Contact Information	Fill in the contact information.

Table 3-3-4-1 SNMP Parameters

3.3.4.2 MIB View

This section explains how to configure MIB view for the objects.

Figure 3-3-4-2

MIB View	
Item	Description
View Name	Set MIB view's name.
View Filter	Select from "Included" and "Excluded".

View OID	Enter the OID number.
Included	You can query all nodes within the specified MIB node.
Excluded	You can query all nodes except for the specified MIB node.

Table 3-3-4-2 MIB View Parameters

3.3.4.3 VACM

This section describes how to configure VCAM parameters.

The screenshot shows the VACM configuration page with tabs for SNMP, MIB View, VACM (selected), Trap, and MIB. Below the tabs is the 'SNMP v1 & v2 User List' section. It contains a table with columns: Community, Permission, MIB View, Network, and Operation. Two rows are visible: one for 'private' and one for 'public', both with 'Read-Write' permission, 'All' MIB View, and '0.0.0.0/0' Network. Each row has a blue 'X' icon in the Operation column. A blue '+' icon is at the bottom right.

Figure 3-3-4-3

VACM	
Item	Description
SNMP v1 & v2 User List	
Community	Set the community name.
Permission	Select from "Read-Only" and "Read-Write".
MIB View	Select an MIB view to set permissions from the MIB view list.
Network	The IP address and bits of the external network accessing the MIB view.
Read-Write	The permission of the specified MIB node is read and write.
Read-Only	The permission of the specified MIB node is read only.
SNMP v3 User Group	
Group Name	Set the name of SNMPv3 group.
Security Level	Select from "NoAuth/NoPriv", "Auth/NoPriv", and "Auth/Priv".
Read-Only View	Select an MIB view to set permission as "Read-only" from the MIB view list.
Read-Write View	Select an MIB view to set permission as "Read-write" from the MIB view list.
Inform View	Select an MIB view to set permission as "Inform" from the MIB view list.
SNMP v3 User List	
Username	Set the name of SNMPv3 user.
Group Name	Select a user group to be configured from the user group.
Authentication	Select from "MD5", "SHA", and "None".
Authentication Password	The password should be filled in if authentication is "MD5" and "SHA".
Encryption	Select from "AES", "DES", and "None".
Encryption Password	The password should be filled in if encryption is "AES" and "DES".

Table 3-3-4-3 VACM Parameters

3.3.4.4 Trap

This section explains how to enable network monitoring by SNMP trap.

Figure 3-3-3-4

SNMP Trap	
Item	Description
Enable	Enable or disable SNMP Trap function.
SNMP Version	Select SNMP version; support SNMP v1/v2c/v3.
Server Address	Fill in NMS's IP address or domain name.
Port	Fill in UDP port. Port range is 1-65535. The default port is 162.
Name	Fill in the group name when using SNMP v1/v2c; fill in the username when using SNMP v3.
Auth/Priv Mode	Select from "NoAuth & No Priv", "Auth & NoPriv", and "Auth & Priv".

Table 3-3-4-4 Trap Parameters

3.3.4.5 MIB

This section describes how to download MIB files. The last MIB file "LTE-ROUTER-MIB.txt" is for the UR32L router.

Figure 3-3-4-5

MIB	
Item	Description
MIB File	Select the MIB file you need.

Download	Click "Download" button to download the MIB file to PC.
----------	---

Table 3-3-4-5 MIB Download

3.3.5 AAA

AAA access control is used for visitors control and the available corresponding services once access is allowed. It adopts the same method to configure three independent safety functions. It provides modularization methods for following services:

- Authentication: verify if the user is qualified to access to the network.
- Authorization: authorize related services available for the user.
- Charging: record the utilization of network resources.

3.3.5.1 Radius

Using UDP for its transport, Radius is generally applied in various network environments with higher requirements of security and permission of remote user access.

Figure 3-3-5-1

Radius	
Item	Description
Enable	Enable or disable Radius.
Server IP Address	Fill in the Radius server IP address/domain name.
Server Port	Fill in the Radius server port. Range: 1-65535.
Key	Fill in the key consistent with that of Radius server in order to get connected with Radius server.

Table 3-3-5-1 Radius Parameters

3.3.5.2 TACACS+

Using TCP for its transport, TACACS+ is mainly used for authentication, authorization and charging of the access users and terminal users by adopting PPP and VPDN.

Figure 3-3-5-2

TACACS+	
Item	Description
Enable	Enable or disable TACACS+.
Server IP Address	Fill in the TACACS+ server IP address/domain name.
Server Port	Fill in the TACACS+ server port. Range: 1-65535.
Key	Fill in the key consistent with that of TACACS+ server in order to get connected with TACACS+ server.

Table 3-3-5-2 TACACS+ Parameters

3.3.5.3 LDAP

A common usage of LDAP is to provide a central place to store usernames and passwords. This allows many different applications and services to connect the LDAP server to validate users.

LDAP is based on a simpler subset of the standards contained within the X.500 standard. Because of this relationship, LDAP is sometimes called X.500-lite as well.

Figure 3-3-5-3

LDAP	
Item	Description
Enable	Enable or Disable LDAP.
Server IP Address	Fill in the LDAP server's IP address/domain name. The maximum count is 10.
Server Port	Fill in the LDAP server's port. Range: 1-65535
Base DN	The top of LDAP directory tree.
Security	Select secure method from "None", "StartTLS" and "SSL".
Username	Enter the username to access the server.
Password	Enter the password to access the server.

Table 3-3-5-3 LDAP Parameters

3.3.5.4 Authentication

AAA supports the following authentication ways:

- None: uses no authentication, generally not recommended.
- Local: uses the local username database for authentication.
 - Advantages: rapidness, cost reduction.
 - Disadvantages: storage capacity limited by hardware.
- Remote: has user's information stored on authentication server. Radius, TACACS+ and LDAP supported for remote authentication.

When radius, TACACS+, and local are configured at the same time, the priority level is: 1 > 2 > 3.

Service	1	2	3
Console	None ▼	None ▼	None ▼
Web	None ▼	None ▼	None ▼
Telnet	None ▼	None ▼	None ▼
SSH	None ▼	None ▼	None ▼

Save

Figure 3-3-5-4

Authentication	
Item	Description
Console	Select authentication for Console access.
Web	Select authentication for Web access.
Telnet	Select authentication for Telnet access.

SSH	Select authentication for SSH access.
-----	---------------------------------------

Table 3-3-5-4 Authentication Parameters

3.3.6 Device Management

3.3.6.1 DeviceHub

You can connect the device to the Milesight DeviceHub on this page so as to manage the router centrally and remotely. For more details please refer to *DeviceHub User Guide*.

Figure 3-3-6-1

DeviceHub	
Item	Description
Status	Show the connection status between the router and the DeviceHub.
Disconnected	Click this button to disconnect the router from the DeviceHub.
Server Address	IP address or domain of the device management server.
Activation Method	Select activation method to connect the router to the DeviceHub server, options are "By Authentication Code" and "By Account name".
Authentication Code	Fill in the authentication code generated from the DeviceHub.
Account name	Fill in the registered DeviceHub account (email) and password.
Password	

Table 3-3-6-1

3.3.6.2 Milesight VPN

You can connect the device to the Milesight VPN on this page so as to manage the router and connected devices centrally and remotely. For more details please refer to *MilesightVPN User Guide*.

Figure 3-3-6-2

Milesight VPN	
Item	Description
Milesight VPN Settings	
Server	Enter the IP address or domain name of Milesight VPN.
Port	Enter the HTTPS port number.
Authorization code	Enter the authorization code which generated by Milesight VPN.
Device Name	Enter the name of the device.
Milesight VPN Status	
Status	Show the connection information about whether the router is connected to the Milesight VPN.
Local IP	Show the virtual IP of the router.
Remote IP	Show the virtual IP of the Milesight VPN.
Duration	Show the information on how long the router has been connected to the Milesight VPN.

Table 3-3-6-2

3.3.7 Events

Event feature is capable of sending alerts by Email when certain system events occur.

3.3.7.1 Events

You can view alarm messages on this page.

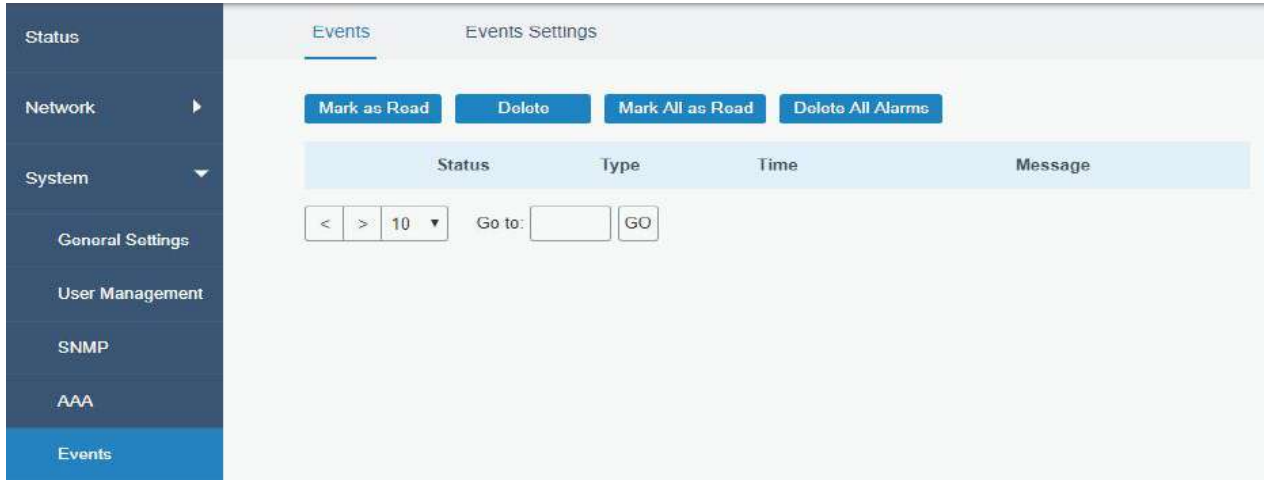

Figure 3-3-7-1

Events	
Item	Description
Mark as Read	Mark the selected event alarm as read.
Delete	Delete the selected event alarm.
Mark All as Read	Mark all event alarms as read.
Delete All Alarms	Delete all event alarms.
Status	Show the reading status of the event alarms, such as "Read" and "Unread".
Type	Show the event type that should be alarmed.
Time	Show the alarm time.
Message	Show the alarm content.

Table 3-3-7-1 Events Parameters

3.3.7.2 Events Settings

In this section, you can decide what events to record and whether you want to receive email and SMS notifications when any change occurs.

Events [Events Settings](#)

Events Settings

Enable

Phone Group List

Email Group List

Events	Record <input type="checkbox"/>	Email <input type="checkbox"/> Email Group List	SMS <input type="checkbox"/> Phone Group List	SNMP <input type="checkbox"/>
System Startup	<input type="checkbox"/>	<input type="checkbox"/>	<input type="checkbox"/>	<input type="checkbox"/>
System Reboot	<input type="checkbox"/>	<input type="checkbox"/>	<input checked="" type="checkbox"/>	<input checked="" type="checkbox"/>
System Time Update	<input type="checkbox"/>	<input type="checkbox"/>	<input checked="" type="checkbox"/>	<input checked="" type="checkbox"/>
VPN Up	<input type="checkbox"/>	<input type="checkbox"/>	<input type="checkbox"/>	<input type="checkbox"/>
VPN Down	<input type="checkbox"/>	<input type="checkbox"/>	<input type="checkbox"/>	<input type="checkbox"/>
WAN Up	<input type="checkbox"/>	<input type="checkbox"/>	<input type="checkbox"/>	<input type="checkbox"/>
WAN Down	<input type="checkbox"/>	<input type="checkbox"/>	<input type="checkbox"/>	<input type="checkbox"/>
Link switch	<input type="checkbox"/>	<input type="checkbox"/>	<input type="checkbox"/>	<input type="checkbox"/>
Weak Signal	<input type="checkbox"/>	<input type="checkbox"/>	<input type="checkbox"/>	<input type="checkbox"/>
Cellular Up	<input type="checkbox"/>	<input type="checkbox"/>	<input type="checkbox"/>	<input type="checkbox"/>

Figure 3-3-7-2

Cellular Down	<input checked="" type="checkbox"/>	<input type="checkbox"/>	<input type="checkbox"/>	<input type="checkbox"/>
Cellular Data Stats Clear	<input type="checkbox"/>	<input type="checkbox"/>	<input type="checkbox"/>	<input type="checkbox"/>
Cellular Data Traffic is running out	<input type="checkbox"/>	<input type="checkbox"/>	<input type="checkbox"/>	<input type="checkbox"/>
Cellular Data Traffic Overflow	<input type="checkbox"/>	<input type="checkbox"/>	<input type="checkbox"/>	<input type="checkbox"/>

Figure 3-3-7-3

Event Settings	
Item	Description
Enable	Check to enable "Events Settings".
Phone Group List	Select phone group to receive SMS alarm.
Email Group List	Select email group to receive alarm.
Record	The relevant content of event alarm will be recorded on "Event" page if this option is checked.
Email	The relevant content of event alarm will be sent out via email if this option is checked.
Email Setting	Click and you will be redirected to the page "Email" to configure email group list.
SMS	The relevant content of event alarm will be sent out via SMS if this option is checked.
SMS Setting	Click and you will be redirected to the page of "Phone" to

	configure phone group list.
VPN Up	VPN is connected.
VPN Down	VPN is disconnected.
WAN Up	Ethernet cable is connected to WAN port.
WAN Down	Ethernet cable is disconnected to WAN port.
Link Switch	Switch to use other interface for Internet access.
Weak Signal	The signal level of cellular is low.
Cellular Up	Cellular network is connected.
Cellular Down	Cellular network is disconnected.
Cellular Data Stats Clear	Zero out the data usage of the main SIM card.
Cellular Data Traffic is running out	The main SIM card is reaching the data usage limit.
Cellular Data Traffic Over Flow	The main SIM card has exceeded the data usage plan.

Table 4-3-7-2 Events Parameters

Related Topics

[Email Setting](#)

[Events Application Example](#)

3.4 Maintenance

This section describes system maintenance tools and management.

3.4.1 Tools

Troubleshooting tools includes ping, traceroute, packet analyzer and qxdmlog.

3.4.1.1 Ping

Ping tool is engineered to ping outer network.

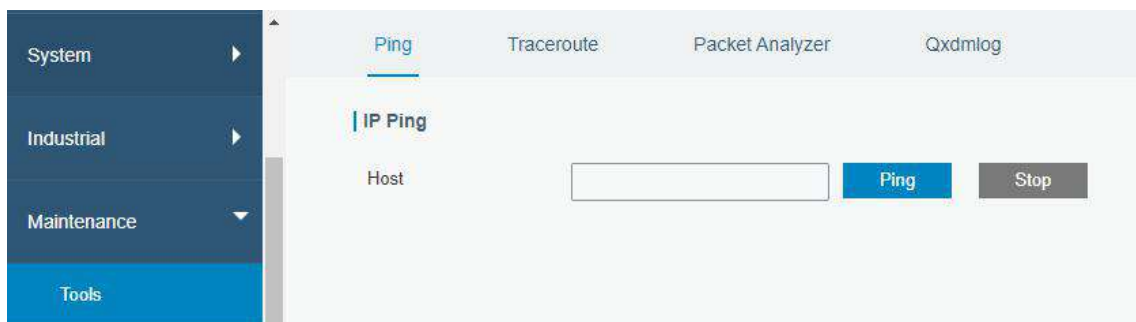

Figure 3-4-1-1

PING	
Item	Description
Host	Ping outer network from the router.

Table 3-4-1-1 IP Ping Parameters

3.4.1.2 Traceroute

Traceroute tool is used for troubleshooting network routing failures.

Figure 3-4-1-2

Traceroute	
Item	Description
Host	Address of the destination host to be detected.

Table 3-4-1-2 Traceroute Parameters

3.4.1.3 Packet Analyzer

Packet Analyzer is used for capturing the packet of different interfaces.

Figure 3-4-1-3

Packet Analyzer	
Item	Description
Ethernet Interface	Select the interface to capture packages.
IP Address	Set the IP address that the router will capture.
Port	Set the port that the router will capture.
Advanced	Set the rules for sniffer. The format is tcpdump.

Table 3-4-1-3 Packet Analyzer Parameters

3.4.1.4 Qxdmlog

This section allow collecting diagnostic logs via QXDM tool.



Figure 3-4-1-4

3.4.2 Debugger

3.4.2.1 Cellular Debugger

This section explains how to send AT commands to router and check cellular debug information.

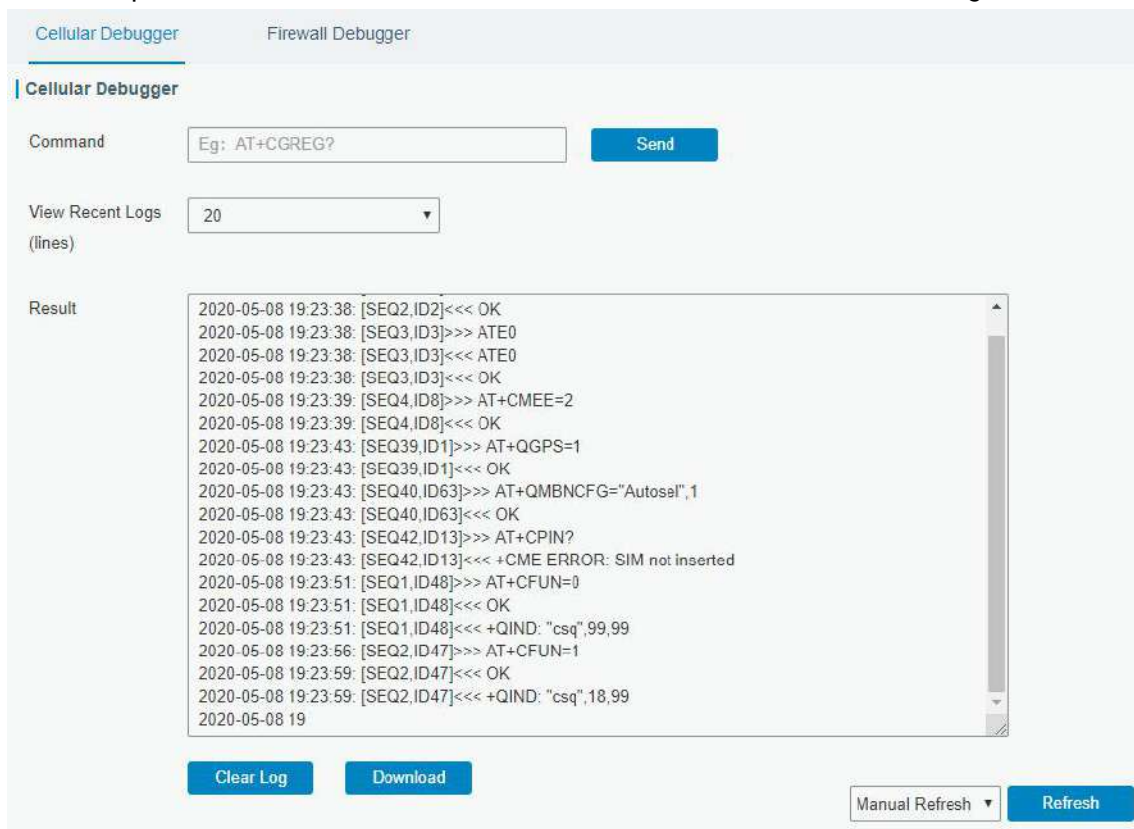

Figure 3-4-2-1

Cellular Debugger	
Item	Description
Command	Enter the AT command that you want to send to cellular modem.
View Recent Logs (lines)	View the specified lines of the result.
Result	Show the response result from cellular modem.

Table 3-4-2-1 Cellular Debugger Parameters

3.4.2.2 Firewall Debugger

This section explains how to send commands to router and check firewall information.

Figure 3-4-2-2

Firewall Debugger	
Item	Description
Command	Enter the AT command that you want to send to firewall module.
Result	Show the response result from firewall module.

Table 3-4-2-2 Firewall Debugger Parameters

3.4.3 Log

The system log contains a record of informational, error and warning events that indicates how the system processes. By reviewing the data contained in the log, an administrator or user troubleshooting the system can identify the cause of a problem or whether the system processes are loading successfully. Remote log server is feasible, and router will upload all system logs to remote log server such as Syslog Watcher.

3.4.3.1 System Log

This section describes how to view the recent log on web.

Figure 3-4-3-1

System Log	
Item	Description
View recent (lines)	View the specified lines of system log.
Clear Log	Clear the current system log.

Table 3-4-3-1 System Log Parameter

3.4.3.2 Log Download

This section describes how to download log files.

File Name	File Size/KB	Creation Time	Operation
vpn.log	1	2020/04/30 14:37:55	↓
system.log	872	2020/05/08 19:35:03	↓
httpd.log	645	2020/05/08 19:34:12	↓
firewall.log	0	2020/04/30 14:37:09	↓
cellular.log	1619	2020/05/08 19:35:01	↓

Figure 3-4-3-2

Log Download	
Item	Description
Download All	Download all log files.

File Name	Show the name of log files.
File Size/KB	Show the size of log files.
Creation Time	Show the creation time of log files.
Operation	Click to download every log file.

Table 3-4-3-2 System Log Parameter

3.4.3.3 Log Settings

This section explains how to enable remote log server and local log setting.

Figure 3-4-3-3

Log Settings	
Item	Description
Remote Log Server	
Enable	With "Remote Log Server" enabled, router will send all system logs to the remote server.
Syslog Server Address	Fill in the remote system log server address (IP/domain name).
Port	Fill in the remote system log server port.
Local Log File	
Storage	User can store the log file in memory or TF card.
Size	Set the size of the log file to be stored.
Log Severity	The list of severities follows the syslog protocol.

Table 3-4-3-3 Log Settings Parameters

3.4.4 Upgrade

This section describes how to upgrade the router firmware via web. Generally you don't need to do the firmware upgrade.

Note: any operation on web page is not allowed during firmware upgrade, otherwise the upgrade will be interrupted, or even the device will break down.

Figure 3-4-4-1

Upgrade	
Item	Description
Firmware Version	Show the current firmware version.
Reset Configuration to Factory Default	When this option is checked, the router will be reset to factory defaults after upgrade.
Upgrade Firmware	Click "Browse" button to select the new firmware file, and click "Upgrade" to upgrade firmware.

Table 3-4-4-1 Upgrade Parameters

Related Configuration Example

[Firmware Upgrade](#)

3.4.5 Backup and Restore

This section explains how to create a complete backup of the system configurations to a file, restore the config file to the router and reset to factory defaults.

Figure 3-4-5-1

Backup and Restore	
Item	Description
Config File	Click "Browse" button to select configuration file, and then click "Import" button to upload the configuration file to the router.
Backup	Click "Backup" to export the current configuration file to the PC.
Reset	Click "Reset" button to reset factory default settings. Router will restart after reset process is done.

Table 3-4-5-1 Backup and Restore Parameters

Related Configuration Example

[Restore Factory Defaults](#)

3.4.6 Reboot

On this page you can reboot the router immediately or regularly. We strongly recommend clicking "Save" and "Apply" button before rebooting the router so as to avoid losing the new configuration.

Figure 3-4-6-1

Reboot	
Item	Description
Reboot Now	Reboot the router immediately.
Schedule	
Enable	Reboot the router at a scheduled frequency.
Cycles	Select the date and time to execute the schedule.

Table 3-4-2-1 Schedule Parameters

Chapter 4 Application Examples

4.1 Restore Factory Defaults

4.1.1 Via Web Interface

1. Log in web interface, and go to "Maintenance > Backup and Restore".
2. Click "Reset" button under the "Restore Factory Defaults".

You will be asked to confirm if you'd like to reset it to factory defaults. Then click "Reset" button.

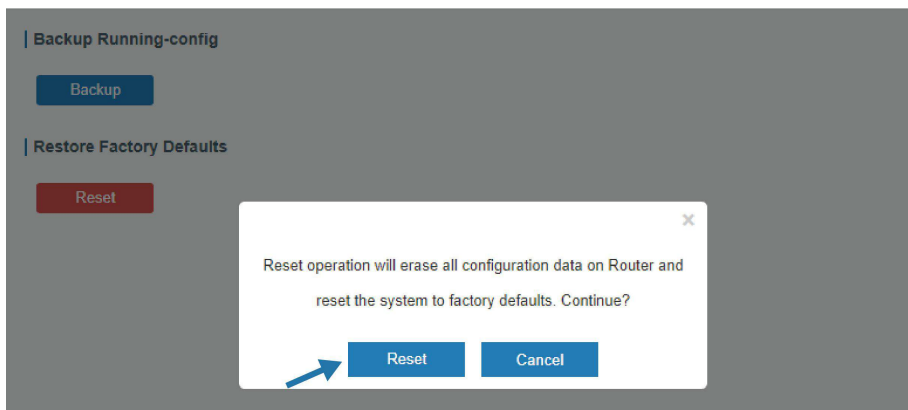
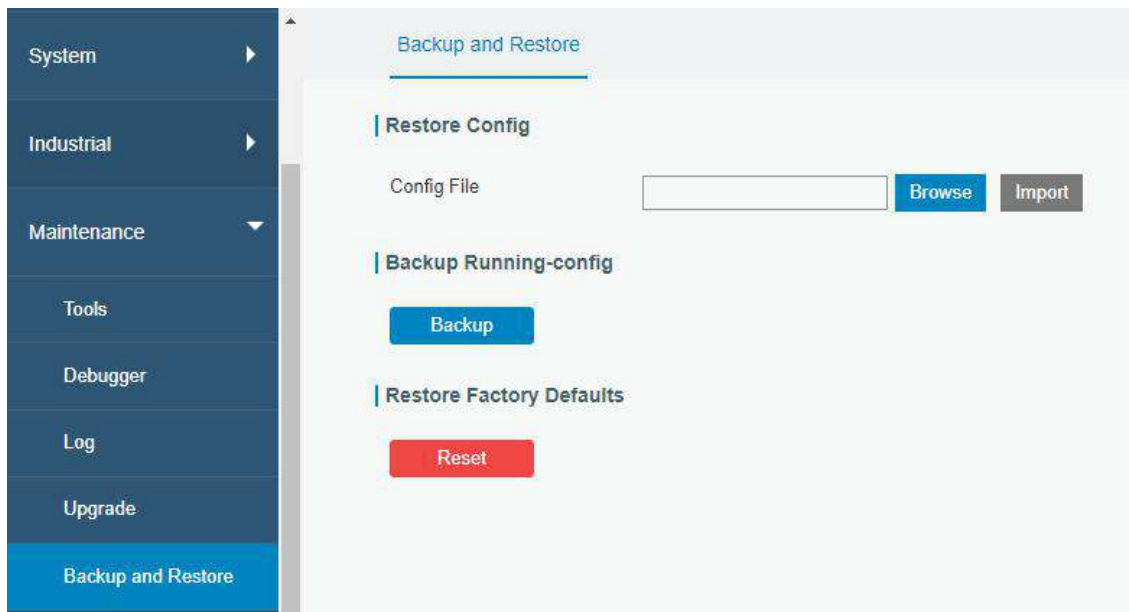

Then the router will reboot and restore to factory settings immediately.

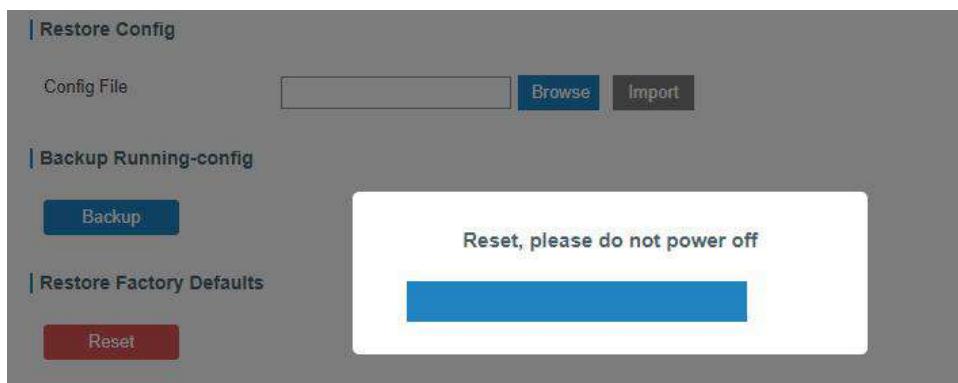

Please wait till the SYSTEM LED blinks slowly and login page pops up again, which means the router has already been reset to factory defaults successfully.

Related Topic

[Restore Factory Defaults](#)

4.2.2 Via Hardware

Locate the reset button on the router, and take corresponding actions based on the status of SYSTEM LED.

SYSTEM LED	Action
Blinking	Press and hold the reset button for more than 5 seconds.
Static Green → Rapidly Blinking	Release the button and wait.
Off → Blinking	The router is now reset to factory defaults.

4.2 Firmware Upgrade

It is suggested that you contact Milesight technical support first before you upgrade router firmware. After getting firmware file please refer to the following steps to complete the upgrade.

1. Go to "Maintenance > Upgrade".
2. Click "Browse" and select the correct firmware file from the PC.
3. Click "Upgrade" and the router will check if the firmware file is correct. If it's correct, the firmware will be imported to the router, and then the router will start to upgrade.

Note: It is recommended to check the box of Reset Configuration to Factory Default before upgrade.

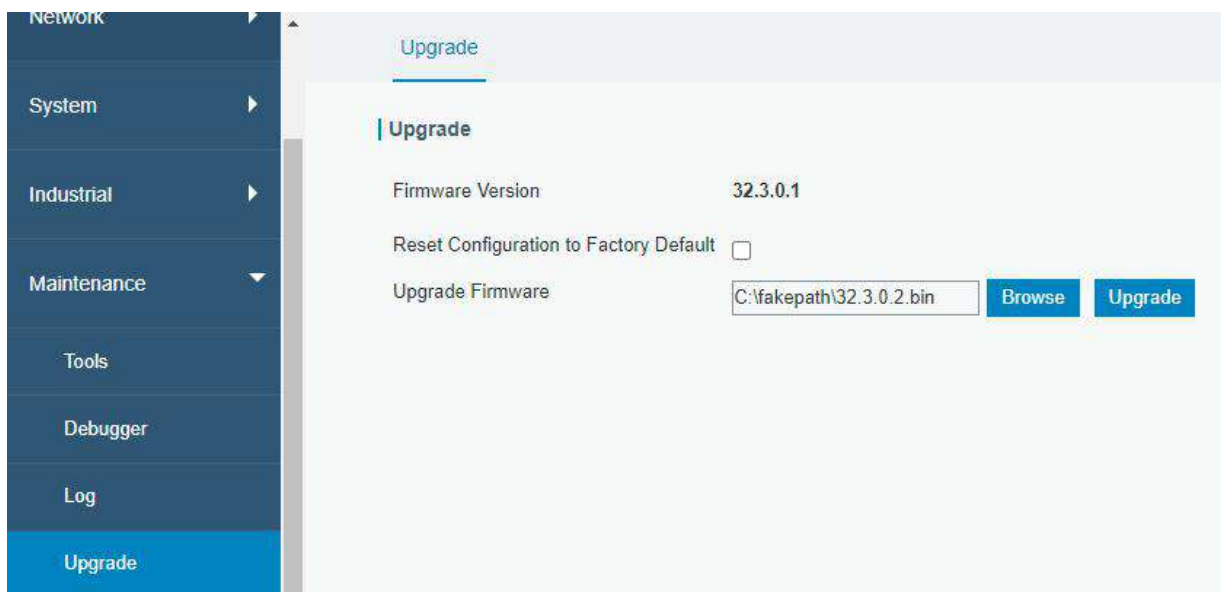

Related Topic

[Upgrade](#)

4.3 Events Application Example

Example

In this section, we will take an example of sending alarm messages by email when the following events occur and recording the event alarms on the Web GUI.

Events	Actions to make events occur (for test)
Router system start up.	Plug the power supply of the router.
Router system time update.	Set up system time manually.

Configuration Steps

1. Go to “System > Events > Events Settings” and enable Event settings.
2. Check corresponding events for record and email alarm, and then click “Save” button as below.

Events	Record	Email Email Setting	SMS SMS Setting	SNMP
System Startup	<input checked="" type="checkbox"/>	<input checked="" type="checkbox"/>	<input type="checkbox"/>	<input type="checkbox"/>
System Reboot	<input type="checkbox"/>	<input type="checkbox"/>	<input type="checkbox"/>	<input type="checkbox"/>
System Time Update	<input checked="" type="checkbox"/>	<input checked="" type="checkbox"/>	<input type="checkbox"/>	<input type="checkbox"/>

3. Configure the corresponding parameters including email sending settings and email groups as below. Click “Save” and “Apply” button to make the changes take effect.

SMTP Client Settings

Enable

Email Address

Password

SMTP Server Address

Port

Encryption

- Start “ManageEngine MibBrowser Free Tool” on the PC. Click “File > Load MIB” on the menu bar. Then select “LTE-ROUTER-MIB.txt” file from PC and upload it to the software.

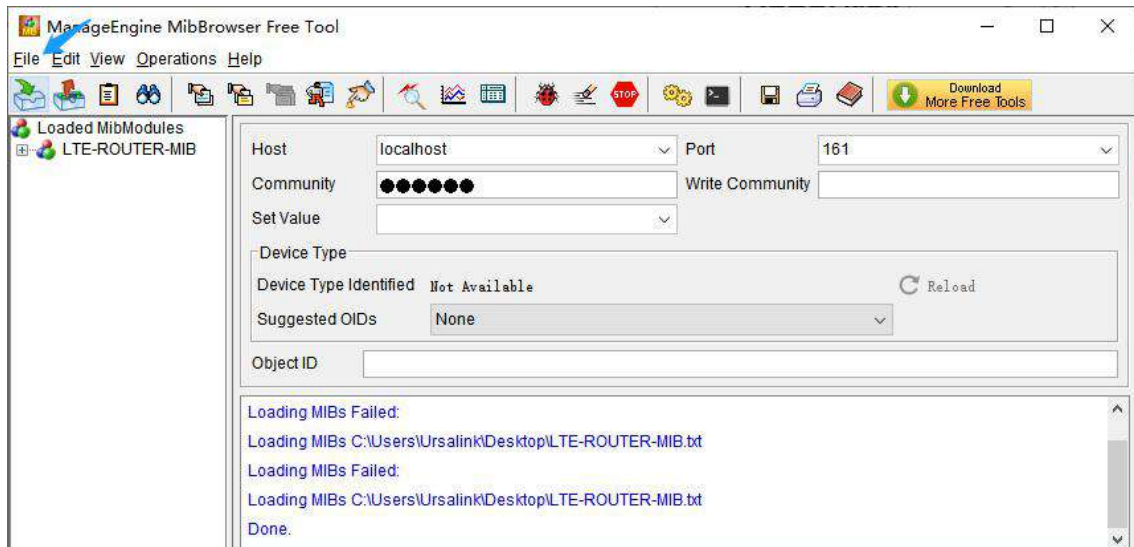

Click the “+” button beside “LTE-ROUTER-MIB”, which is under the “Loaded MibModules” menu, and find “usCellularInfo”. And then you will see the OID of cellular info is “.1.3.6.1.4.1.50234”, which will be filled in the MIB View settings.

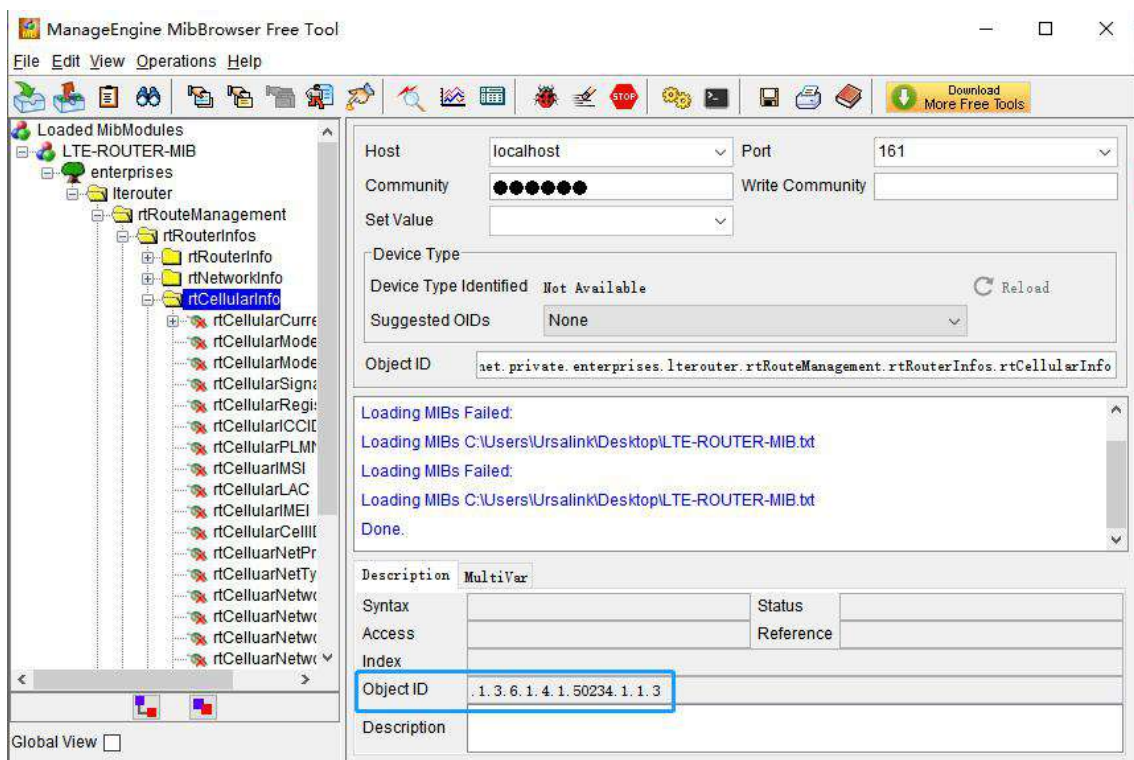

- Go to “System > SNMP > SNMP” on the router’s WEB GUI. Check “Enable” option, then click “Save” button.

SNMP MIB View VACM Trap MIB

SNMP Settings

Enable

Port

SNMP Version

Location Information

Contact Information

4. Go to "System > SNMP > MIB View". Click  to add a new MIB view and define the view to be accessed from the outside network. Then click "Save" button.

SNMP MIB View VACM Trap MIB

View List

View Name	View Filter	View OID	Operation
<input type="text" value="cellular"/>	<input type="text" value="Included"/>	<input type="text" value="1.3.6.1.4.1.50234.1.3"/>	<input type="button" value="X"/>
			<input type="button" value="+"/>

5. Go to "System > SNMP > VACM". Click  to add a new VACM setting to define the access authority for the specified view from the specified outside network. Click "Save" and "Apply" to make the changes take effect.

SNMP MIB View VACM Trap MIB

SNMP v1 & v2 User List

Community	Permission	MIB View	Network	Operation
<input type="text" value="public"/>	<input type="text" value="Read-Write"/>	<input type="text" value="cellular"/>	<input type="text" value="0.0.0.0/0"/>	<input type="button" value="X"/>
				<input type="button" value="+"/>

6. Go to MibBrowser, enter host IP address, port and community. Right click "usCellular CurrentSim"

and then click “FET”. Then you will get the current SIM info on the result box. You can get other cellular info in the same way.

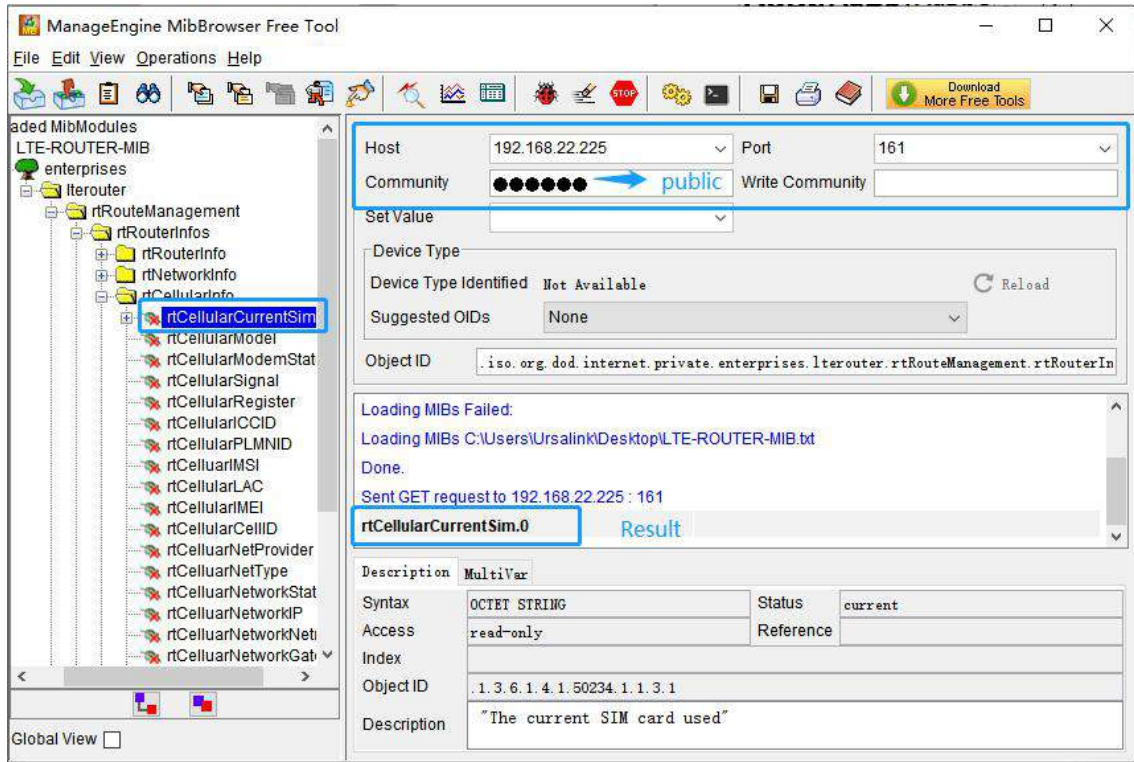

Related Topic

[SNMP](#)

4.5 Network Connection

4.5.1 Cellular Connection

1. Go to “Network > Interface > Cellular > Cellular Setting” and configure the cellular info, then Click “Save” and “Apply” for configuration to take effect.

The screenshot shows the 'Cellular' settings page in the Milesight IoT web interface. The left sidebar contains a navigation menu with options: Status, Network, Interface (selected), DHCP, Firewall, QoS, VPN, IP Passthrough, Routing, VRRP, DDNS, System, and Maintenance. The main content area is titled 'Cellular Settings' and includes the following fields:

- Protocol Type: IPv4/IPv6 (dropdown)
- APN: (text input)
- Username: (text input)
- Password: (text input)
- PIN Code: (text input)
- Access Number: (text input)
- Authentication Type: Auto (dropdown)
- Network Type: 4G Only (dropdown)
- PPP Preferred:
- SMS Center: (text input)
- Enable NAT:
- Roaming:
- Data Limit: 0 MB (text input)
- Billing Day: Day 1 of The Month (dropdown)

2. Go to “Network > Interface > Link Failover” to enable cellular interface and change link priority.

The screenshot shows the 'Link Priority' configuration table in the Milesight IoT web interface. The table has the following columns: Priority, Enable Rule, Link in use, Interface, Connection Type, IP, and Operation. The first row is highlighted with a red border, indicating it is the selected configuration.

Priority	Enable Rule	Link in use	Interface	Connection Type	IP	Operation
1	<input checked="" type="checkbox"/>	●	Cellular-SIM1	DHCP	10.142.57.34	
2	<input type="checkbox"/>	●	WAN	Static	192.168.22.212	

3. Click to configure ICMP ping detection information.

The screenshot shows the 'Ping Detection' configuration dialog in the Milesight IoT web interface. The dialog includes the following fields:

- Enable:
- IPv4 Primary Server: 8.8.8.8
- IPv4 Secondary Server: 114.114.114.114
- IPv6 Primary Server: 2001:4860:4860::8888
- IPv6 Secondary Server: 2400:3200::1
- Interval: 300 s
- Retry Interval: 5 s
- Timeout: 3 s
- Max Ping Retries: 3

At the bottom of the dialog are two buttons: 'OK' and 'Cancel'.

4. Check the cellular connection status by WEB GUI of router.

Click "Status > Cellular" to view the status of the cellular connection. If it shows 'Connected', the SIM has dialed up successfully.

Overview	Cellular	Network	VPN	Routing	Host List
Modem			Network		
Model	EC25	Status	Connected		
Version	EC25EUXGAR08A05M1G	IPv4 Address	10.142.57.34/30		
Signal Level	23asu (-67dBm)	IPv4 Gateway	10.142.57.33		
Register Status	Registered (Home network)	IPv4 DNS	211.136.17.107		
IMEI	862506043707416	IPv6 Address	fe80::cca3:25ff:fed2:908:64		
IMSI	460081370507437	IPv6 Gateway	::		
ICCID	88860493262190157437	IPv6 DNS	::		
ISP	CHINA MOBILE	Connection Duration	0 days, 00:23:21		
Network Type	TDD LTE	Data Usage Monthly			
PLMN ID	46000	RX	4.0 MIB		
LAC	592f	TX	2.8 MIB		
Cell ID	ceb972a	ALL	6.8 MIB		

5. Check out if network works properly by browser on PC.

Open your preferred browser on PC, type any available web address into address bar and see if it is able to visit Internet via the UR32L router.

Related Topic

[Cellular Setting](#)

[Cellular Status](#)

4.5.2 Ethernet WAN Connection

Example

WAN port of the UR32L is connected with Ethernet cable to get Internet access.

Configuration Steps

- Go to "Network > Interface > WAN" to select connection type and configure WAN parameters. The following examples of static IP type, DHCP Client type, and PPPoE type are listed for your reference.

Note: if you select PPPoE type, please check the "Username" & "Password" with your local ISP.

Click "Save & Apply" button to make the changes take effect.

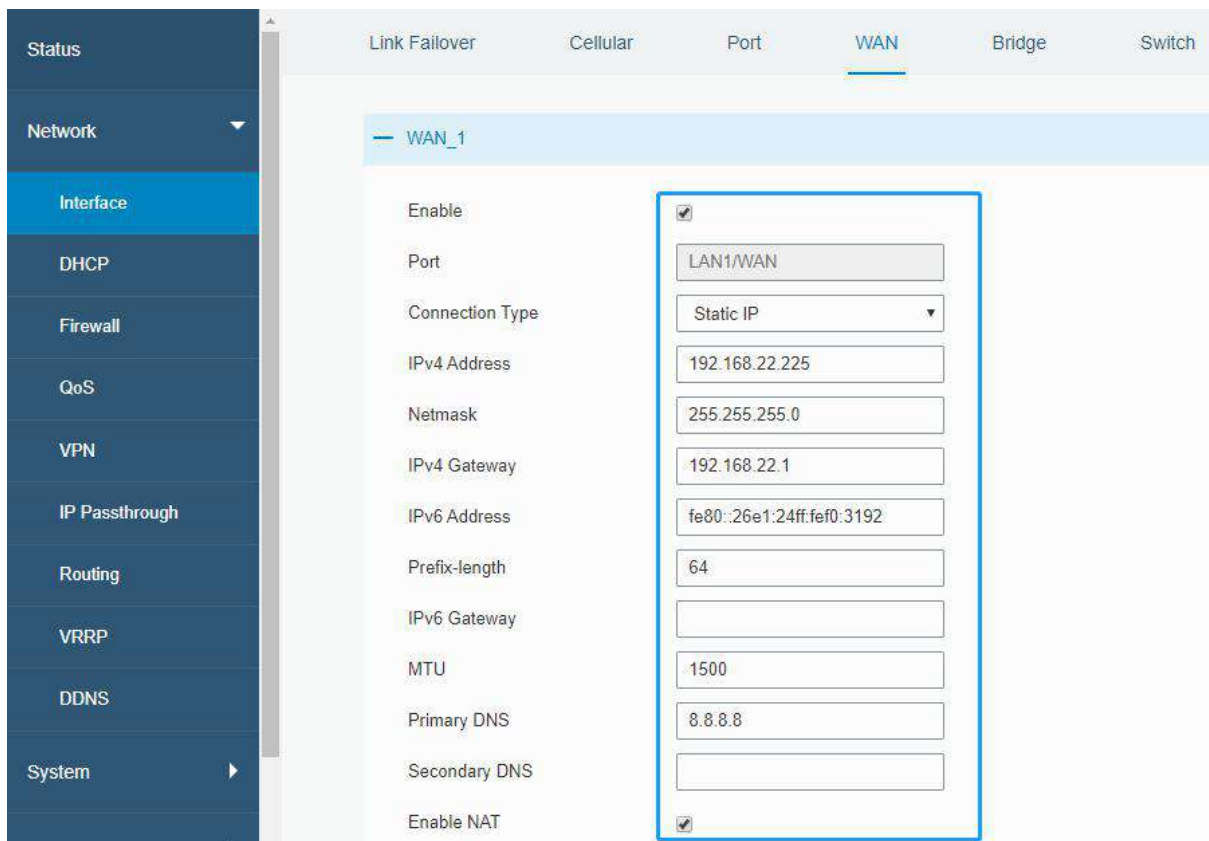

2. Go to "Network > Interface > Link Failover" to change the WAN priority to 1.

Priority	Enable Rule	Link in use	Interface	Connection Type	IP	Operation
1	<input checked="" type="checkbox"/>	<input type="radio"/>	WAN	Static	192.168.22.212	
2	<input checked="" type="checkbox"/>	<input checked="" type="radio"/>	Cellular-SIM1	DHCP	10.142.57.34	

Related Topic

[WAN Setting](#)

[WAN Status](#)

4.6 VRRP Application Example

Application Example

A Web server requires Internet access through the UR32L router. To avoid data loss caused by router breakdown, two UR32L routers can be deployed as VRRP backup group, so as to improve network reliability.

VRRP group:

WAN ports of the UR32L Router A and Router B are connected to the Internet via wired network. And LAN ports of them are connected to a switch.

Virtual IP is 192.168.1.254/24.

UR32L Router	Virtual Router ID (Same for A and B)	Port connected with switch	LAN IP Address	Priority	Preemption Mode
A	1	LAN2	192.168.1.1	110	Enable
B	1	LAN2	192.168.1.2	100	Disable

Refer to the topological below.

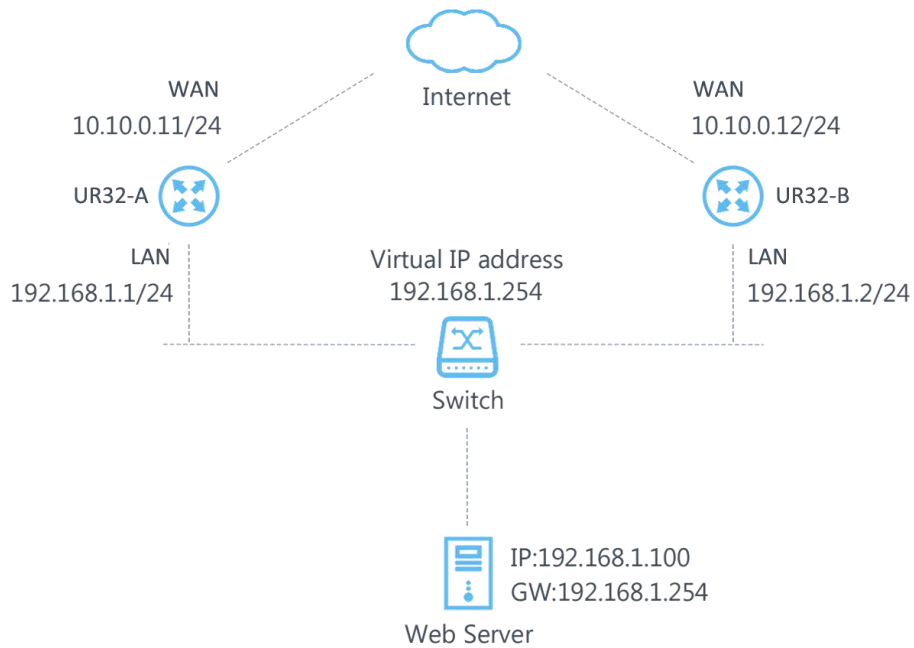

Configuration Steps

Router A Configuration

1. Go to "Network > Interface > WAN" and configure wired WAN connection as below.

Link Failover Cellular Port **WAN** Bridge

WAN Settings

WAN_1

Enable	<input checked="" type="checkbox"/>
Port	LAN1/WAN
Connection Type	Static IP
IPv4 Address	10.10.0.11
Netmask	255.255.255.0
IPv4 Gateway	10.10.0.1
IPv6 Address	fe80::26e1:24ff:fe0:3192
Prefix-length	64
IPv6 Gateway	
MTU	1500
Primary DNS	8.8.8.8
Secondary DNS	
Enable NAT	<input checked="" type="checkbox"/>

- Go to “Network > VRRP > VRRP” and configure VRRP parameters as below.

Status

Network

Interface

DHCP

Firewall

QoS

VPN

IP Passthrough

Routing

VRRP

DDNS

System

VRRP

VRRP Status

Status DISABLE

VRRP Settings

Enable	<input checked="" type="checkbox"/>
Interface	Bridge0
Virtual Router ID	1
Virtual IP	192.168.1.254
Priority	110
Advertisement Interval (s)	1
Preemption Mode	<input type="checkbox"/>
IPv4 Primary Server	8.8.8.8
IPv4 Secondary Server	114.114.114.114
Interval	300 s
Retry Interval	5 s
Timeout	3 s
Max Ping Retries	3

Router B Configuration

1. Go to “Network > Interface > WAN” and configure wired WAN connection as below.

The screenshot shows the WAN Settings configuration page for the WAN_1 interface. The page has tabs for Link Failover, Cellular, Port, WAN (selected), and Bridge. The WAN Settings section is expanded to show the WAN_1 configuration. The settings are as follows:

Parameter	Value
Enable	<input checked="" type="checkbox"/>
Port	LAN1/WAN
Connection Type	Static IP
IPv4 Address	10.10.0.12
Netmask	255.255.255.0
IPv4 Gateway	10.10.0.1
IPv6 Address	fe80::26e1:24ff:fe0:3192
Prefix-length	64
IPv6 Gateway	
MTU	1500
Primary DNS	8.8.8.8
Secondary DNS	
Enable NAT	<input checked="" type="checkbox"/>

2. Go to “Network > VRRP > VRRP” and configure VRRP parameters as below.

The screenshot shows the VRRP configuration page. The left sidebar has a menu with the following items: Status, Network, Interface, DHCP, Firewall, QoS, VPN, IP Passthrough, Routing, VRRP (selected), DDNS, and System. The VRRP configuration page has a Status of DISABLE. The VRRP Settings section is expanded to show the following parameters:

Parameter	Value
Enable	<input checked="" type="checkbox"/>
Interface	Bridge0
Virtual Router ID	1
Virtual IP	192.168.1.254
Priority	100
Advertisement Interval (s)	1
Preemption Mode	<input type="checkbox"/>
IPV4 Primary Server	8.8.8.8
IPV4 Secondary Server	114.114.114.114
Interval	300 s
Retry Interval	5 s
Timeout	3 s
Max Ping Retries	3

Once you complete all configurations, click “Apply” button on the top-right corner to make changes take effect.

Result: normally, A is the master router, used as the default gateway. When the power of Router A is down or Router A suffers from failure, Router B will become the master router, used as the default gateway. With Preemption Mode enabled, Router A will be master and Router B will demote back to be the backup once Router A can access the Internet again.

Related Topics

[VRRP Setting](#)

4.7 NAT Application Example

Example

An UR32L router can access Internet via cellular. LAN port is connected with a Web server whose IP address is 192.168.1.2 and port is 8000. Configure the router to make public network access the server.

Configuration Steps

Go to “Firewall > Port Mapping” and configure port mapping parameters.

The screenshot shows the Milesight web interface for configuring Port Mapping. The interface includes a sidebar with navigation options: Status, Network, Interface, DHCP, Firewall (selected), and QoS. The main content area shows the Port Mapping configuration page. The page title is "Port Mapping" and it includes a "Save" button and an "Apply" button. The configuration table has the following columns: Source IP, Source Port, Destination IP, Destination Port, Protocol, Description, and Operation. A row is added with the following values: Source IP: 0.0.0.0/0, Source Port: 8000, Destination IP: 192.168.1.2, Destination Port: 800, Protocol: TCP, and Operation: +. The "Save" button is labeled with a circled 4, and the "Apply" button is labeled with a circled 5.

Source IP	Source Port	Destination IP	Destination Port	Protocol	Description	Operation
0.0.0.0/0	8000	192.168.1.2	800	TCP		+

Click “Save” and “Apply” button.

Related Topic

[Port Mapping](#)

4.8 Access Control Application Example

Application Example

LAN port of the UR32L is set with IP 192.168.1.0/24. Then configure the router to deny accessing to Google IP 172.217.160.100 from local device with IP 192.168.1.12.

Configuration Steps

- Go to “Network > Firewall > ACL” to configure access control list. Click “+” button to set parameters as below. Then click “Save” button.

The screenshot shows the ACL configuration interface. The 'ACL Setting' section has a 'Default Filter Policy' dropdown set to 'Accept'. The 'Access Control List' section contains the following fields:

- Type: extended
- ID: 100
- Action: deny
- Protocol: ip
- Source IP: 192.168.1.12
- Source Wildcard Mask: 0.0.0.255
- Destination IP: 172.217.160.100
- Destination Wildcard Mask: 0.0.0.255
- Description: google

At the bottom, there are 'Save' and 'Cancel' buttons.

- Configure interface list. Then click “Save” and “Apply” button.

The screenshot shows the ACL configuration interface with the 'Access Control List' and 'Interface List' sections. The 'Access Control List' section contains a table with the following data:

ID	Action	Protocol	Source IP	Destination IP	More Detail	Description	Operation
100	deny	ip	192.168.1.12/0.0.0.255	172.217.160.100/0.0.255		google	

The 'Interface List' section contains a table with the following data:

Interface	In ACL	Out ACL	Operation
Bridge0	100		

Related Topic

[ACL](#)

4.9 QoS Application Example

Example

Configure the UR32L router to distribute local preference to different FTP download channels. The total download bandwidth is 75000 kbps.

Note: the “Total Download Bandwidth” should be less than the real maximum bandwidth of WAN or cellular interface.

FTP Server IP & Port	Percent	Max Bandwidth(kbps)	Min Bandwidth(kbps)
110.21.24.98:21	40%	30000	25000
110.32.91.44:21	60%	45000	40000

Configuration Steps

- Go to “Network > QoS > QoS(Download)” to enable QoS and set the total download bandwidth.

Download Bandwidth

Enable

Default Category

Download Bandwidth kbits/s

Capacity

- Please find “Service Category” option, and click “+” to set up service classes.

Note: the percents must add up to 100%.

Service Category

Name	Percent(%)	Max BW(kbps)	Min BW(kbps)	Operation
1	40	30000	25000	<input type="button" value="X"/>
2	60	45000	40000	<input type="button" value="X"/>

- Please find “Service Category Rules” option, and click “+” to set up rules.

Service Category Rules

Name	Source IP	Source Port	Destination IP	Destination Port	Protocol	Service Category	Operation
ftp1	110.21.24.98	21			ANY	1	<input type="button" value="X"/>
ftp2	110.32.91.44	21			ANY	2	<input type="button" value="X"/>

Note:

IP/Port: null refers to any IP address/port.

Click “Save” and “Apply” button.

Related Topic

[QoS Setting](#)

4.10 PPTP Application Example

Example

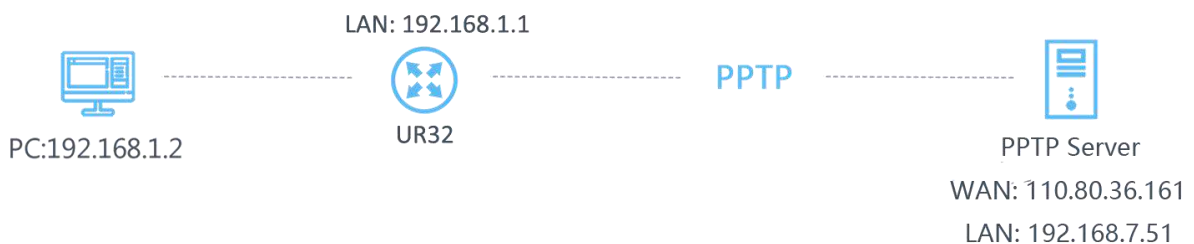

Configure the UR32L as PPTP client to connect to a PPTP server in order to have data transferred securely. Refer to the following topological graph.

Configuration Steps

1. Go to “Network > VPN > PPTP”, configure PPTP server IP address, username and password provided by PPTP server.

Note: If you want to have all data transferred through VPN tunnel, check “Global Traffic Forwarding” option.

The screenshot shows the configuration page for PPTP. The page has tabs for DMVPN, IPsec, GRE, L2TP, and PPTP, with PPTP selected. Below the tabs is a section for Certifications. The main content area is titled "PPTP Settings" and contains a sub-section for "PPTP_1". The settings are as follows:

Enable	<input checked="" type="checkbox"/>
Remote IP Address	110.87.98.58
Username	pptpserver
Password	*****
Authentication	Auto
Global Traffic Forwarding	<input type="checkbox"/>
Remote Subnet	
Remote Subnet Mask	
Advanced Settings	<input type="checkbox"/>

If you want to access peer subnet such as 192.168.3.0/24, you need to configure the subnet and mask to add the route.

Remote Subnet	<input type="text" value="192.168.3.0"/>
Remote Subnet Mask	<input type="text" value="255.255.255.0"/>

2. Check "Show Advanced" option, and you will see the advanced settings.

DMVPN	IPsec	GRE	L2TP	<u>PPTP</u>
Show Advanced		<input checked="" type="checkbox"/>		
Local IP Address		<input type="text"/>		
Peer IP Address		<input type="text"/>		
Enable NAT		<input checked="" type="checkbox"/>		
Enable MPPE		<input type="checkbox"/>		
Address/Control Compression		<input type="checkbox"/>		
Protocol Field Compression		<input type="checkbox"/>		
Asyncmap Value		<input type="text" value="ffffff"/>		
MRU		<input type="text" value="1500"/>		
MTU		<input type="text" value="1500"/>		
Link Detection Interval (s)		<input type="text" value="60"/>		
Max Retries		<input type="text" value="0"/>		
Expert Options		<input type="text"/>		

If the PPTP server requires MPPE encryption, then you need to check "Enable MPPE" option.

Enable MPPE

If the PPTP server assigns fixed tunnel IP to the client, then you can fill in the local tunnel IP and remote tunnel IP, shown as below.

Local IP Address	<input type="text" value="205.205.0.100"/>
Peer IP Address	<input type="text" value="205.205.0.1"/>

Otherwise PPTP server will assign tunnel IP randomly.

Click "Save" button when you complete all settings, and then the advanced settings will be hidden again. Then click "Apply" button to have the configurations take effect.

3. Go to "Status > VPN" and check PPTP connection status.

PPTP is established as shown below.

Local IP: the client tunnel IP.

Remote IP: the server tunnel IP.

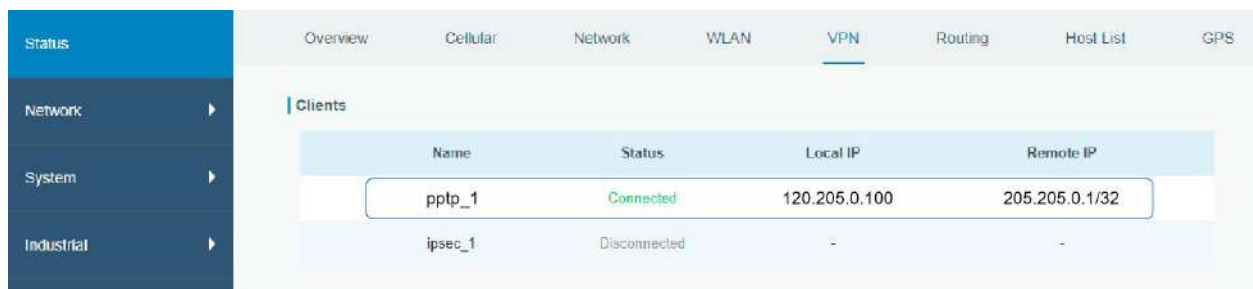

The screenshot shows the Milesight IoT web interface. On the left is a navigation menu with 'Status' selected. The main content area has tabs for 'Overview', 'Cellular', 'Network', 'WLAN', 'VPN', 'Routing', 'Host List', and 'GPS'. The 'VPN' tab is active, displaying a 'Clients' table. The table has four columns: 'Name', 'Status', 'Local IP', and 'Remote IP'. Two rows are visible: 'pptp_1' with status 'Connected', local IP '120.205.0.100', and remote IP '205.205.0.1/32'; and 'ipsec_1' with status 'Disconnected', local IP '-', and remote IP '-'.

Name	Status	Local IP	Remote IP
pptp_1	Connected	120.205.0.100	205.205.0.1/32
ipsec_1	Disconnected	-	-

Related Topics

[PPTP Setting](#)

[PPTP Status](#)

[END]